



Product description

- The mic+ sensor with two switching outputs measures the distance to an object within the detection zone contactless. Depending on the adjusted detect distance the switching output is set.
- All settings are done with two push-buttons and a three-digit LED-display (TouchControl).
- Three-colour LEDs indicate the switching status.
- The output functions are changeable from NOC to NCC.
- The sensors are adjustable manually via TouchControl or via Teach-in procedure.
- Useful additional functions are set in the Add-on-menu.
- Using the LinkControl adapter (optional accessory) all TouchControl and additional sensor parameter settings can be adjusted by a Windows® Software.

Operating Manual

mic+ Ultrasonic Sensors with two switching outputs

mic+25/DD/TC	mic+25/EE/TC
mic+35/DD/TC	mic+35/EE/TC
mic+130/DD/TC	mic+130/EE/TC
mic+340/DD/TC	mic+340/EE/TC
mic+600/DD/TC	mic+600/EE/TC

settings can be adjusted by a Windows® Software.

Safety Notes

- Read the operating instructions prior to start-up.
- Connection, installation and adjustment works may only be carried out by expert personnel.
- No safety component in accordance with the EU Machine Directive, use in the area of personal and machine protection not permitted

Proper Use

mic+ ultrasonic sensors are used for non-contact detection of objects.

The mic+ sensors have a blind zone in which distance measurement is not possible. The operating range indicates the distance of the sensor that

can be applied with normal reflectors with sufficient function reserve. When using good reflectors, such as a calm water surface, the sensor can also be used up to its maximum range. Objects that strongly absorb (e.g. plastic foam) or diffusely reflect sound (e.g. pebble stones) can also reduce the defined operating range.

Synchronisation

If the assembly distance of multiple sensors falls below the values shown in Fig. 1 the integrated synchronisation should be used. Connect Sync/Com-channels (pin 5 at the units receptacle) of all sensors (10 maximum).

mic+25...	≥0.35 m	≥2.50 m
mic+35...	≥0.40 m	≥2.50 m
mic+130...	≥1.10 m	≥8.00 m
mic+340...	≥2.00 m	≥18.00 m
mic+600...	≥4.00 m	≥30.00 m

Fig. 1: Assembly distances, indicating synchronisation/multiplex

Multiplex mode

The Add-on-menu allows to assign an individual address »01« to »10« to each sensor connected via the Sync/Com-channel (Pin5). The sensors perform the ultrasonic measurement sequentially from low to high address. Therefore any influence between the sensors is rejected. The address »00« is reserved to synchronisation mode and deactivates the multiplex mode. To use synchronised mode all sensors must be set to address »00«.

Installation

- Assemble the sensor at the installation location.
- Plug in the connector cable to the M12 connector, see Fig. 2.

	+U _B	brown
	-U _B	blue
	D2	black
	D1	white
	Sync/Com	grey

Fig. 2: Pin assignment with view onto sensor plug and colour coding of the microsonic connection cable

Start-up

- Connect the power supply.
- Set the parameters of the sensor manually via TouchControl (see Fig. 3 and Diagram 1)
- or use the Teach-in procedure to adjust the detect points (see Diagram 2).

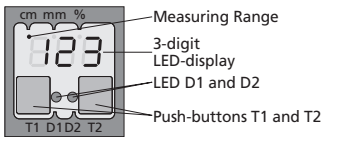

Fig. 3: TouchControl/LED display

Factory setting

mic+ sensors are delivered factory made with the following settings:

- Switching outputs on NOC
- Detecting distance at operating range and half operating range
- Measurement range set to maximum range

Maintenance

mic+ sensors work maintenance free. Small amounts of dirt on the surface do not influence function. Thick layers of dirt and caked-on dirt affect sensor function and therefore must be removed.

Notes

- mic+ sensors have internal temperature compensation. Because the sensors heat up on their own, the temperature compensation reaches its optimum working point after approx. 30 minutes of operation.
- During normal operating mode, a yellow LED signals that the switching output has connected.
- During normal operating mode, the measured distance value is displayed on the LED-indicator in mm (up to 999 mm) or cm (from 100 cm). Scale switches automatically and is indicated by a point on top of the digits.
- During Teach-in mode, the hysteresis loops are set back to factory settings.
- If no objects are placed within the detection zone the LED-indicator shows »--«.
- If no push-buttons are pressed for 20 seconds during parameter setting mode the made changes are stored and the sensor returns to normal operating mode.

- The sensor can be reset to its factory setting, see »Key lock and factory setting«, Diagram 3.

Show parameters

- In normal operating mode shortly push T1. The LED display shows »PAR.«

Each time you tap push-button T1 the actual settings of the switching outputs are shown.

Diagram 1: Set sensor parameters numerically using LED display

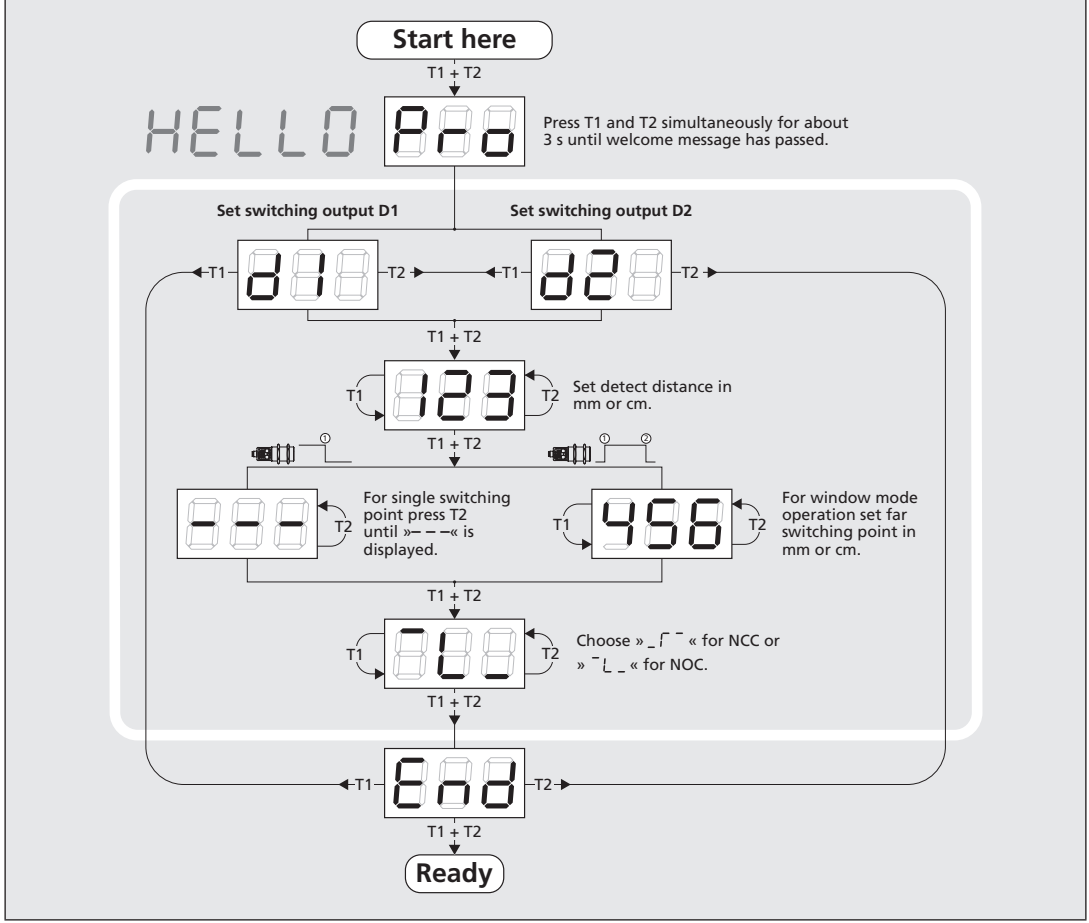

Diagram 2: Set sensor parameters via Teach-in procedure

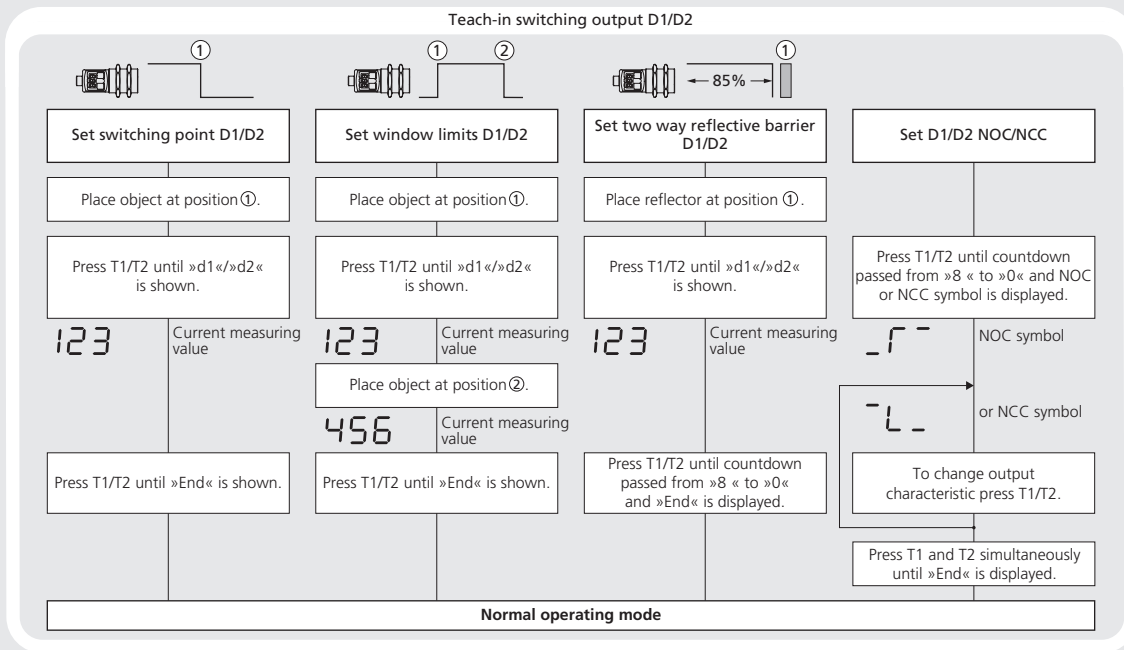

Diagram 3: Key lock and factory setting

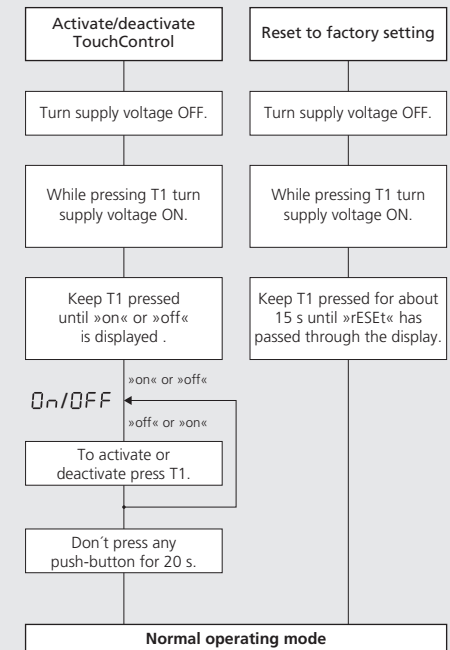
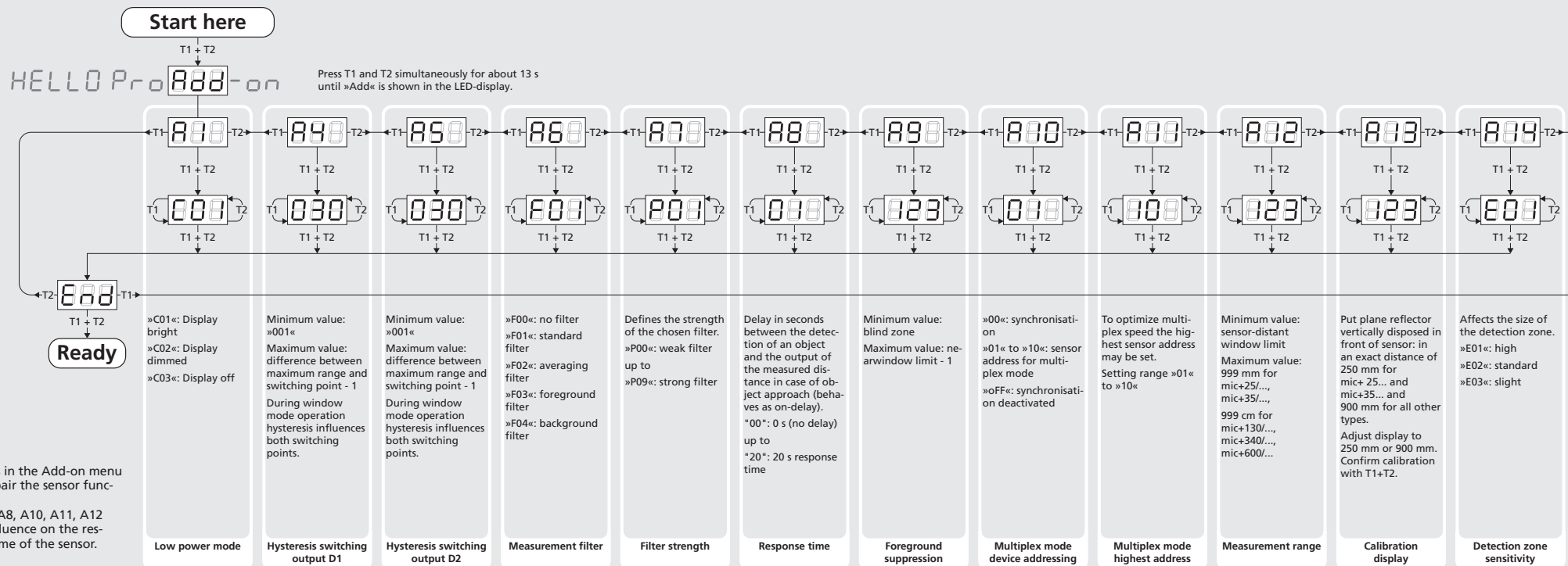
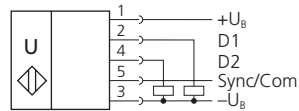

Diagram 4: Useful additional functions in Add-on menu (for experienced users only, settings not required for standard applications)



Technical data



2 pnp switching outputs

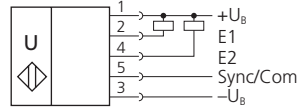

2 npn switching outputs

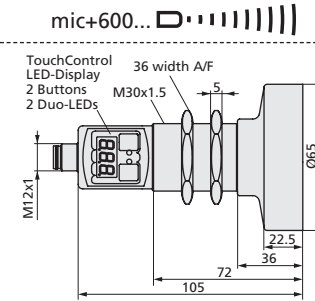
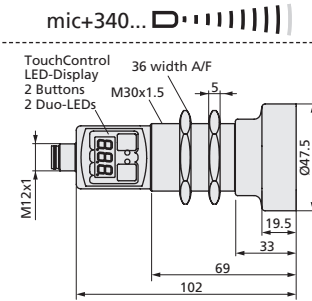
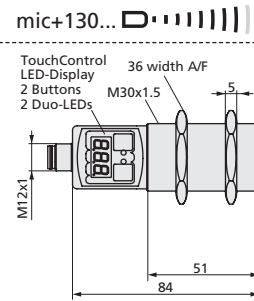
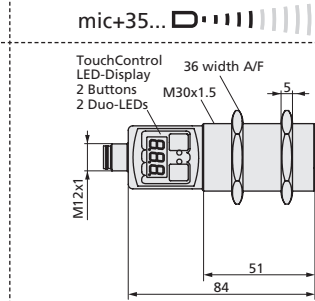
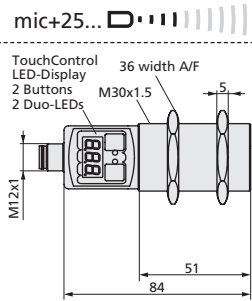

blind zone 0 to 30 mm
operating range 250 mm
maximum range 350 mm
angle of beam spread see detection zone
transducer frequency 320 kHz
resolution 0.025 mm

blind zone 0 to 65 mm
operating range 350 mm
maximum range 600 mm
angle of beam spread see detection zone
transducer frequency 400 kHz
resolution 0.025 mm

blind zone 0 to 200 mm
operating range 1,300 mm
maximum range 2,000 mm
angle of beam spread see detection zone
transducer frequency 200 kHz
resolution 0.18 mm

blind zone 0 to 350 mm
operating range 3,400 mm
maximum range 5,000 mm
angle of beam spread see detection zone
transducer frequency 120 kHz
resolution 0.18 mm

blind zone 0 to 600 mm
operating range 6,000 mm
maximum range 8,000 mm
angle of beam spread see detection zone
transducer frequency 80 kHz
resolution 0.18 mm

detection zones
 for different objects:
 The dark grey areas represent the zone where it is easy to recognise the normal reflector (round bar). This indicates the typical operating range of the sensors. The light grey areas represent the zone where a very large reflector – for instance a plate – can still be recognised. The requirement here is for an optimum alignment to the sensor. It is not possible to evaluate ultrasonic reflections outside this area.

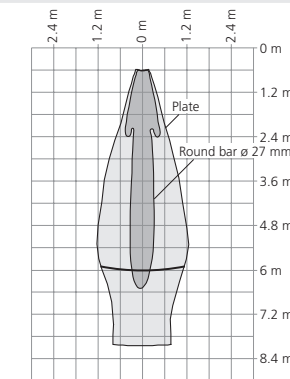
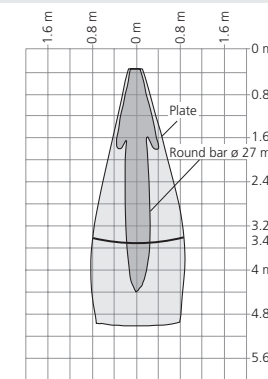
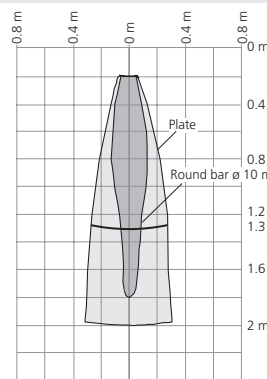
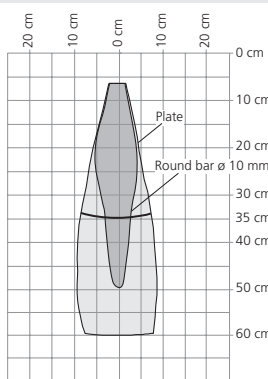
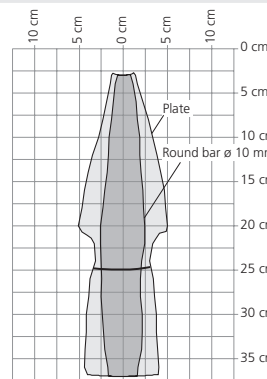

reproducibility ±0.15 %
accuracy ±1 % (Temperature drift internal compensated, may be deactivated³⁾, 0.17%/K without compensation)
operating voltage U_B 9 to 30 V DC, short-circuit-proof, Class 2
voltage ripple ±10 %
no-load supply current ≤ 80 mA
housing Brass sleeve, nickel-plated, plastic parts: PBT, TPU; Ultrasonic transducer: polyurethane foam, epoxy resin with glass content
class of protection to EN 60529 IP 67
norm conformity EN 60947-5-2
type of connection 5-pin initiator plug, PBT
controls 2 push-buttons (TouchControl)
indicators 3-digit LED display, 2 three-colour LEDs with TouchControl and LinkControl
programmable with TouchControl and LinkControl
operating temperature -25 to +70 °C
storage temperature -40 to +85 °C
weight 150 g
switching hysteresis¹⁾ 3 mm
switching frequency²⁾ 25 Hz
response time²⁾ 32 ms
time delay before availability <300 ms

reproducibility ±0.15 %
accuracy ±1 % (Temperature drift internal compensated, may be deactivated³⁾, 0.17%/K without compensation)
operating voltage U_B 9 to 30 V DC, short-circuit-proof, Class 2
voltage ripple ±10 %
no-load supply current ≤ 80 mA
housing Brass sleeve, nickel-plated, plastic parts: PBT, TPU; Ultrasonic transducer: polyurethane foam, epoxy resin with glass content
class of protection to EN 60529 IP 67
norm conformity EN 60947-5-2
type of connection 5-pin initiator plug, PBT
controls 2 push-buttons (TouchControl)
indicators 3-digit LED display, 2 three-colour LEDs with TouchControl and LinkControl
programmable with TouchControl and LinkControl
operating temperature -25 to +70 °C
storage temperature -40 to +85 °C
weight 150 g
switching hysteresis¹⁾ 5 mm
switching frequency²⁾ 12 Hz
response time²⁾ 64 ms
time delay before availability <300 ms

reproducibility ±0.15 %
accuracy ±1 % (Temperature drift internal compensated, may be deactivated³⁾, 0.17%/K without compensation)
operating voltage U_B 9 to 30 V DC, short-circuit-proof, Class 2
voltage ripple ±10 %
no-load supply current ≤ 80 mA
housing Brass sleeve, nickel-plated, plastic parts: PBT, TPU; Ultrasonic transducer: polyurethane foam, epoxy resin with glass content
class of protection to EN 60529 IP 67
norm conformity EN 60947-5-2
type of connection 5-pin initiator plug, PBT
controls 2 push-buttons (TouchControl)
indicators 3-digit LED display, 2 three-colour LEDs with TouchControl and LinkControl
programmable with TouchControl and LinkControl
operating temperature -25 to +70 °C
storage temperature -40 to +85 °C
weight 150 g
switching hysteresis¹⁾ 20 mm
switching frequency²⁾ 8 Hz
response time²⁾ 92 ms
time delay before availability <300 ms

reproducibility ±0.15 %
accuracy ±1 % (Temperature drift internal compensated, may be deactivated³⁾, 0.17%/K without compensation)
operating voltage U_B 9 to 30 V DC, short-circuit-proof, Class 2
voltage ripple ±10 %
no-load supply current ≤ 80 mA
housing Brass sleeve, nickel-plated, plastic parts: PBT, TPU; Ultrasonic transducer: polyurethane foam, epoxy resin with glass content
class of protection to EN 60529 IP 67
norm conformity EN 60947-5-2
type of connection 5-pin initiator plug, PBT
controls 2 push-buttons (TouchControl)
indicators 3-digit LED display, 2 three-colour LEDs with TouchControl and LinkControl
programmable with TouchControl and LinkControl
operating temperature -25 to +70 °C
storage temperature -40 to +85 °C
weight 210 g
switching hysteresis¹⁾ 50 mm
switching frequency²⁾ 4 Hz
response time²⁾ 172 ms
time delay before availability <380 ms

reproducibility ±0.15 %
accuracy ±1 % (Temperature drift internal compensated, may be deactivated³⁾, 0.17%/K without compensation)
operating voltage U_B 9 to 30 V DC, short-circuit-proof, Class 2
voltage ripple ±10 %
no-load supply current ≤ 80 mA
housing Brass sleeve, nickel-plated, plastic parts: PBT, TPU; Ultrasonic transducer: polyurethane foam, epoxy resin with glass content
class of protection to EN 60529 IP 67
norm conformity EN 60947-5-2
type of connection 5-pin initiator plug, PBT
controls 2 push-buttons (TouchControl)
indicators 3-digit LED display, 2 three-colour LEDs with TouchControl and LinkControl
programmable with TouchControl and LinkControl
operating temperature -25 to +70 °C
storage temperature -40 to +85 °C
weight 270 g
switching hysteresis¹⁾ 100 mm
switching frequency²⁾ 3 Hz
response time²⁾ 240 ms
time delay before availability <450 ms

order No. mic+25/DD/TC
switching output 2 x pnp, U_B – 2 V, I_{max} = 2 x 200 mA
 switchable NOC/NCC, short-circuit-proof

order No. mic+35/DD/TC
switching output 2 x pnp, U_B – 2 V, I_{max} = 2 x 200 mA
 switchable NOC/NCC, short-circuit-proof

order No. mic+130/DD/TC
switching output 2 x pnp, U_B – 2 V, I_{max} = 2 x 200 mA
 switchable NOC/NCC, short-circuit-proof

order No. mic+340/DD/TC
switching output 2 x pnp, U_B – 2 V, I_{max} = 2 x 200 mA
 switchable NOC/NCC, short-circuit-proof

order No. mic+600/DD/TC
switching output 2 x pnp, U_B – 2 V, I_{max} = 2 x 200 mA
 switchable NOC/NCC, short-circuit-proof

order No. mic+25/EE/TC
switching output 2 x npn, –U_B + 2 V, I_{max} = 2 x 200 mA
 switchable NOC/NCC, short-circuit-proof

order No. mic+35/EE/TC
switching output 2 x npn, –U_B + 2 V, I_{max} = 2 x 200 mA
 switchable NOC/NCC, short-circuit-proof

order No. mic+130/EE/TC
switching output 2 x npn, –U_B + 2 V, I_{max} = 2 x 200 mA
 switchable NOC/NCC, short-circuit-proof

order No. mic+340/EE/TC
switching output 2 x npn, –U_B + 2 V, I_{max} = 2 x 200 mA
 switchable NOC/NCC, short-circuit-proof

order No. mic+600/EE/TC
switching output 2 x npn, –U_B + 2 V, I_{max} = 2 x 200 mA
 switchable NOC/NCC, short-circuit-proof

¹⁾ Can be programmed via TouchControl and LinkControl.

²⁾ With TouchControl and LinkControl, the selected filter setting and the maximum range influence the switching frequency and the response time.

³⁾ Can be deactivated via LinkControl.



Enclosure Type 1
 For use only in industrial machinery NFPA 79 applications.

The proximity switches shall be used with a Listed (CYI/7) cable/connector assembly rated minimum 32 Vdc, minimum 290 mA, in the final installation.

