



Operating manual

Ultrasonic double sheet detection with 2 switched outputs

dbk+5/3CDD/M18 E+S
dbk+5/3BEE/M18 E+S

Functional principle

The function of the double sheet detection is to detect two or more sheets or other laminary materials lying one on top of the other. The sensor system consists of a transmitter and a receiver complete with integrated evaluation electronics. A high-frequency ultrasonic transmitter beams from the underside against the sheet material. The emitted ultrasonic pulse excites the sheet material into vibrations. The effect of these vibrations is for a very small sonic wave on the other side of the sheet to spread. This wave is received by the ultrasonic receiver located there. In the case of sheet one on top of the other (double sheet), the receiver detects the difference in signal and sets its outputs accordingly.

Product description

- Assured detection of single, double and multiple sheet.
- Scanning of sheet material weights from 100 g/m² to 2,000 g/m², corrugated cards, sheet metals, printed circuit boards, films and plastic sheets up to several mm thickness possible.
- Double sheet and missing sheet output as pnp or npn switched outputs.
- Vertical mounting to the sheet running through permitted.
- Three control inputs allow for an external setting of sensitivity for the material to be scanned.
- Changes to sensitivity classes under ongoing operations can be undertaken.
- Additional teach-in mode e.g. for scanning wafers glued with a water film.
- Optional trigger operation mode e.g. for applications in the shingled stream.
- Parameterization via LinkControl
- 0.5 ms response time until a double or missing sheet in the trigger mode is detected.
- Transmitter-receiver spacing can be selected from 30 to 70 mm

Safety tips

- Read the operating instructions before start-up.
- Only qualified personnel are to undertake connection, mounting and settings.
- Not a safety component in keeping with the EC Machinery Directive.

Mounting

- Mount transmitter and receiver in keeping with Fig 1 at the recommended spacing of 50 mm ± 3 mm. dbk+5 can be fitted at any position.
- Connect the transmitter to the receiver using the M8 connector.
- Connect the receiver 7-strand control line in keeping with Fig 2.

Pointer

- If required, spacing between trans-

mitter and receiver can be adjusted to the local circumstances in the 30 to 70 mm range; see under »Teach-in spacing between transmitter and receiver«.

- The coaxiality of transmitter and receiver must be ≤ 0.5 mm.
- Transmitter and receiver are not to be inclined to each other in excess of 2°.
- Vertical mounting to the sheet is recommended for papers (Fig 1a).
- In case of vertical mounting to the sheet, the spacing between transmitter and/or receiver and the sheet running through is not to be under 7 mm.
- In case of certain sheet metals or thicker plastic films, the dbk has to be mounted at an inclination to sheet normal depending on the material (Fig. 1b). If necessary the optimum mounting position has to be determined in a test.
- Thick papers and paperboard responsible for faulty switching in case of vertical mounting can often be scanned at a 27° to 45° mounting angle to sheet normal. Corrugated cards have to be measured obliquely to the waves (Fig 1c).
- Other materials may make a special fitting position necessary. Do contact microsonic when you work with these special materials.
- The max. torque of the nuts is 15 Nm for the M18 sleeves.
- The drill hole must be ≥ 12 mm given that the transmitter is recess-mounted or a sheet feed is envisaged between transmitter and receiver. The recommendation is for a 18 mm diameter (see Fig 1).
- The line between transmitter and receiver is not to be bridged with an external potential.

Symbol	Colour
+U _B	Brown
-U _B	Blue
Single/missing sheet output	White
Double sheet output	Black
Control input C1	Violet
Control input C2	Pink
Control input C3/Com	Grey

Fig. 2: Colour coding of the control line

Start-up

- Select the »Standard« sensitivity class by placing all the 3 control inputs onto logic 0 (see Figs 3 and 4) or leave them unconnected. Switch on the dbk+5 voltage supply.

Pointer

- The »Standard« sensitivity class corresponds to the setting of predecessor model dbk-5.

Check the function with a test sheet.

- Hold a single test sheet within the working range between transmitter and receiver.

The LED must light up green for "Single sheet detected«. (Should the LED light up red, then check on the dbk+5 fitting dimension and the selected test sheet.)

- Hold a double test sheet within the working range between transmitter and receiver.

The LED must light up red for "Double sheet detected«.

- Remove all the sheets between transmitter and receiver. The LED must flash red for "Missing sheet detected«.

Pointer

- You can use a material of a high sheet weight as the test sheet or the test sheet itself obtainable as an accessory with the »dbk test sheet« article name. This test sheet works as critical material at the ambient temperature in the »Standard« sensitivity class and can be used to examine the correct adjustment and function.

Factory setting

The dbk+5 are delivered with the following factory settings:

- Free-run mode with 3 sensitivity classes and teach-in
- Missing sheet output on NCI
- Double sheet output on NCI
- 50 mm spacing

Condition	LED 1	LED 2	
single sheet	Green	Green	static on
single sheet overmodulation	Green	Green + Red = Orange	static on
double sheet	Red	Red	static on
missing sheet	Red	Red	flashing
Teach-in activated	Green	Green	flashing mutually
Teach-in dismissed	Red	Red	flashing mutually
Teach-in spacing transmitter-receiver	Red	Green	flashing mutually
Teach-in dismissed	Red	Red	flashing mutually

Fig. 9: LED displays

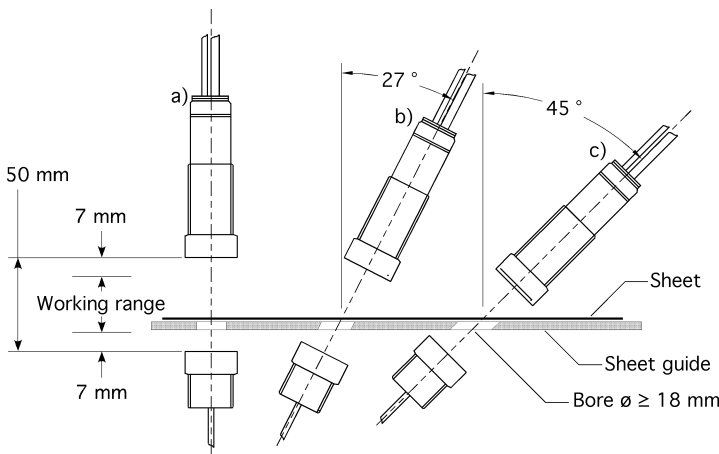

Fig. 1: Mounting and installation positions

Operation in the free-run mode

The dbk+5 operates in the free-run mode ex-works. In the free-run mode, the dbk+5 performs measurements cyclically.

Pointer

- If measurements should be taken in the shingled stream, then an external trigger signal can individually trigger each measurement. To this end, the trigger mode can be parameterized with the help of the LCA-2 LinkControl adapter available as an accessory and the LinkControl software.

Logical state	Voltage level	
	pnp -U _B	nnp +U _B
0		
1	+U _B	-U _B

Fig. 3: Voltage level of the logic states at the control inputs

Sensitivity classes

The fact that the dbk+5 control inputs are unconnected or on logic 0 points to pre-selection of the »Standard« sensitivity class where the range of sheet material weights from a typical 100 g/m² up to 2,000 g/m² can be scanned.

- The 3 control inputs allow the sensitivity classes to be pre-selected in keeping with the Fig 4 table.
- The »Thin« setting has to be selected for thin materials.
- The working range can be enlarged to thicker materials by choosing the setting »Thick«.
- Changes between sensitivity classes can be undertaken under on-going operations.
- Pre-selecting an over-low sensitivity class can result – even with a single sheet – in a double sheet signal appearing. In such an instance, the next-higher sensitivity class is to be pre-selected.
- Pre-selecting an over-high sensitivity class results – given a single sheet – in the double-sheet detection indicating overmodulation at the LEDs: one LED lights up green and the other green-red (orange

blend). In such an instance, the next-lower sensitivity class is to be pre-selected.

Pointer

Parameterization of the D1 switched output onto the »Overmodulation« output function achieved with LinkControl software results in the overmodulation signal being additionally outputted on D1.

Teach-in

The teach-in mode is also available for materials glued to each other across their full extent (e.g. two wafers bonded with a water film, a spline on a paper web) and special materials which cannot be scanned with one of the 3 sensitivity classes

- Select the teach-in mode (C1 and C2 on logic 1) in keeping with the table in Fig 4.

This is the way to teach-in a material:

- Place a single sheet of the material in the working range of the double sheet detection.
- Place the C3 control input on logic 1 for a minimum of 3 seconds. Materials with inhomogeneities must be moved during the teach-in phase so that dbk+5 can detect them.

Success with a teach-in operation is shown by a green LED. In instances of where no material teach-in was possible, dbk+5 flashes in red. Then repeat the operation.

- On finishing the teach-in operation, either place the C3 control input on logic 0 or leave it unconnected.

The material can now be scanned.

Pointer

- C3 must not be on logic 1 when the supply voltage is connected.

	C1	C2	C3
Standard	0	0	0
Thick	0	1	0
Thin	1	0	0
Teach-in-Mode	1	1	0
Teach-in active	1	1	1

Fig. 4: Free-run mode: selection of the sensitivity class and Teach-in

Parameterization with LinkControl

The dbk+5 can be extensively parameterized under LinkControl. Here you need the optionally available LinkControl adapter LCA-2 and the LinkControl software for Windows©.

Operation onto LinkControl

- Install the LinkControl software onto your PC.
Connect the LinkControl adapter to your PC through the USB cable.
- Connect dbk+5 to the LCA-2 in keeping with the Fig 5 table. For this, use the adapter cable in the LCA-2 case.
- Connect the voltage supply cable to the LCA-2 on the other side of the T connector.
- Start the LinkControl software and follow the instructions on the screen.

	Colour dbk+5	Colour adapter cable	Pin
+U _B	Brown	Brown	1
-U _B	Blue	Blue	3
C3/Com	Grey	Grey	5

Fig. 5: Connecting dbk+5 to the LCA-2

The following settings can be undertaken:

- Numeric input of the spacing between transmitter and receiver
- Function for the D1 switched output
Missing sheet = NCC (single sheet = NCO) or
Missing sheet = NCO (single sheet = NCC) or
Overmodulation = NCC or
Overmodulation = NOC

- Function for the D2 switched output
Double sheet = NCI or
Double sheet = NCO

Operating mode

- Free-run mode with 3 pre-defined sensitivity classes and additional teach-in mode or
- Free-run mode with 4 independent teach-in classes or
- Trigger mode with 2 pre-defined sensitivity classes and additional teach-in mode or
- Edge- or level-controlled trigger mode

Also available is a diagrammatic representation of the readings.

Operation in the trigger mode

If LinkControl was used to parameterize the trigger mode, then the external trigger signal is to be placed on the C2 control input.

Available in the trigger mode are sensitivity classes »Standard«, »Thin« and the teach-in mode in keeping with the Fig 6 table.

In the edge-controlled trigger setting (see Fig 7), the double sheet detection takes a measurement with every edge from 0 to 1. The finding is then stored until the next trigger edge.

	C1	C2	C3
Standard	0	Trigger	0
Thick	0	Trigger	1
Teach-in-Mode	1	Trigger	0
Teach-in active	1	Trigger	1

Fig. 6: Trigger mode: selection of the sensitivity class and teach-in mode

In the level-controlled trigger mode, dbk+5 keeps on taking measurements for as long as the trigger signal is on hand. With dbk+5 deactivated (C2 control input to logic 0), the reading of the last measurement at the switched outputs is frozen (see Fig 8).

Free-run mode with 4 independent teach-in classes

Parameterization with the aid of LinkControl of the free-run mode with 4 independent teach-in classes makes teach-in possible for up to 4 different materials. As a result, the »Standard«, »Thick«, »Thin« and »Teach-in mode« sensitivity classes can be individually adjusted (see on-line help in LinkControl).

Teach-in spacing between transmitter and receiver

Teach-in of the selected spacing between transmitter and receiver must be undertaken should you not have mounted transmitter and receiver at the recommended 40 mm or 30 mm spacing.

- Clear the measuring section of sheet materials between transmit-

ter and receiver.

Place all the 3 control inputs on logic 1.

Switch on the supply voltage: The LEDs flash alternately red and green.

Wait at least 2 seconds.

Place the C3 control input on logic 0.

Pointer

- Any failure to teach-in the set spacing results in dbk+5 flashing in red for 3 seconds.

dbk+5 is operating normally. Finally, select the requested type of operation through the control inputs.

Maintenance

No maintenance is needed on the double sheet detection. We would recommend cleaning the sensor surfaces at the transmitter and receiver should they become very dirty. The best thing is to apply some isopropanol onto a cotton cloth and then wipe the surface clean. Make sure that the reaction time of the cleaner is kept down. That means quickly wiping dry the transducer surfaces.

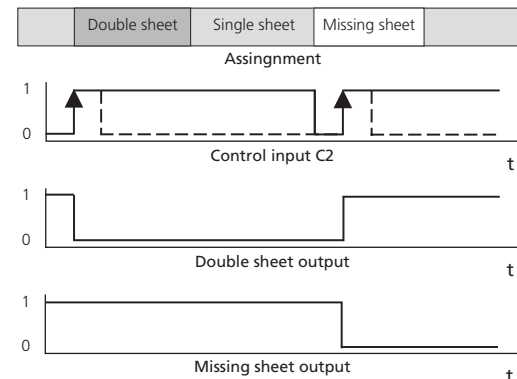

Fig. 7: Trigger mode edge-controlled

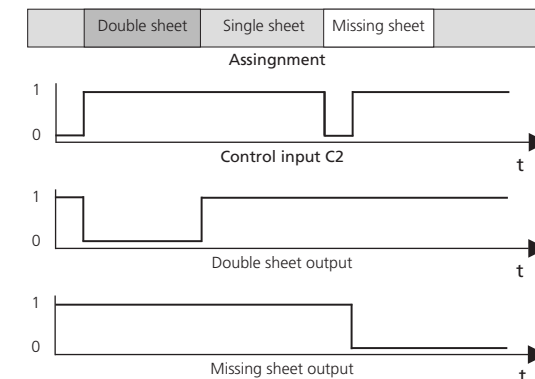
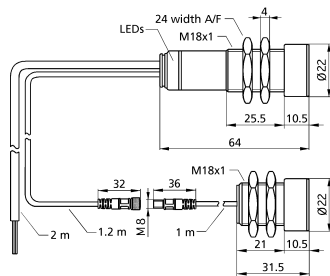
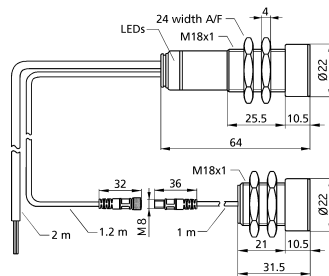

Fig. 8: Trigger-mode level-controlled

dbk+5/3CDD/M18 E+S



dbk+5/3BEE/M18 E+S



spacing transmitter-receiver:	30 to 70 mm	30 to 70 mm
optimum spacing transmitter-receiver:	50 mm ± 3 mm	50 mm ± 3 mm
blind zone (in front of transmitter and receiver):	7 mm	7 mm
permissible angular deviation:	±45° from the perpendicular of the sheet	±45° from the perpendicular of the sheet
ultrasonic frequency:	200 kHz	200 kHz
working range:	papers with grammages of 100 g/m ² to 2,000 g/m ² ; metal-laminated sheets and films up to 5 mm thickness, self-adhesive films, sheet metals up to 2 mm thickness, corrugated cardboard, wafer, printed circuit boards	papers with grammages of 100 g/m ² to 2,000 g/m ² ; metal-laminated sheets and films up to 5 mm thickness, self-adhesive films, sheet metals up to 2 mm thickness, corrugated cardboard, wafer, printed circuit boards
operating voltage U_B:	20 V to 30 V DC	20 V to 30 V DC
voltage ripple:	± 10 %	± 10 %
no-load current consumption:	≤ 50 mA	≤ 50 mA
type of connection:	2 m PUR cable, 7 x 0,25 mm ²	2 m PUR cable, 7 x 0,25 mm ²
transmitter-receiver connection:	At receiver: PUR, 1,2 m; at transmitter: 1 m, PUR; both with 3-pin M8 plug	At receiver: PUR, 1,2 m; at transmitter: 1 m, PUR; both with 3-pin M8 plug
controls:	3 control inputs: C1 to C3	3 control inputs: C1 to C3
programmable:	selection of sensitivity classes, Teach-in, LinkControl < 500 μs	selection of sensitivity classes, Teach-in, LinkControl < 500 μs
release delay Trigger-Mode:	5,5 ms until next edge	5,5 ms until next edge
indicator:	green: working/single sheet red: double sheet red flashing: missing sheet	green: working/single sheet red: double sheet red flashing: missing sheet
housing:	brass sleeve, nickel-plated; plastic parts: PBT, PA; cable: PUR; ultrasonic transducer: Polyurethane, epoxy resin with glass content	brass sleeve, nickel-plated; plastic parts: PBT, PA; cable: PUR; ultrasonic transducer: Polyurethane, epoxy resin with glass content
max. tightening torque of nuts:	15 Nm	15 Nm
class of protection to EN 60529:	IP 65	IP 65
operating temperature:	+5 °C to +60 °C	+5 °C to +60 °C
storage temperature:	-40 °C to +85 °C	-40 °C to +85 °C
weight:	150 g	150 g
norm conformity:	EN 60947-5-2	EN 60947-5-2
order no.:	dbk+5/3CDD/M18 E+S	dbk+5/3BEE/M18 E+S
double sheet output:	pnp, +U _B -2 V, I _{max.} = 200 mA, short circuit proof, switchable NCO/NCI	npn, -U _B +2 V, I _{max.} = 200 mA, short circuit proof, switchable NCO/NCI
missing sheet output:	pnp, +U _B -2 V, I _{max.} = 200 mA, short circuit proof, switchable NCO/NCI	npn, -U _B +2 V, I _{max.} = 200 mA, short circuit proof, switchable NCO/NCI
U_E at control inputs C₁-C₃:	> -U _B + 18 V: logical 1 < -U _B + 13 V or control input open: logical 0	< -U _B + 6 V: logical 1 > -U _B + 10 V or control input open: logical 0
time delay before availability:	< 300 ms	< 750 ms

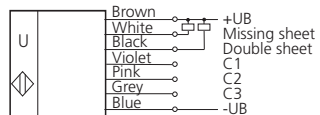
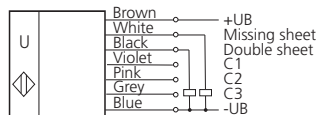

¹⁾ Can be programmed with LinkControl

