

Product Description

The pms sensor has a stainless steel housing and is designed for applications with hygienic requirements. The ultrasonic transducer surface of the pms sensors is laminated with a PTFE film (Teflon film). The transducer itself is sealed against the housing by a joint ring.

The pms sensor with a D12 adapter shaft can be fitted in a mounting clip which meets hygiene standards like the sensor screw connection BF-pms/A1.

The special housing design ensures that any cleaning fluids are able to run off completely, regardless of the installation situation.

The pms sensor is ECOLAB and EHEDG certified.

The pms sensor variant D12 adapter

shaft offers a non-contact measurement of the distance to an object present within the sensor's detection zone. Depending on the set window limits, a distance-proportional analogue signal is the result.

For sensor setting, the accessory LinkControl adapter LCA-2 is recommended in combination with LinkControl software for Windows®. Alternatively, the sensor can also be set by Teach-in via pin 2.

Safety Notes

- Read the operating instructions prior to start-up.
- Connection, installation and adjustment works should be carried out by expert personnel only.
- No safety component in accordance with the EU Machine Directive.

Proper use

pms ultrasonic sensors are used for non-contact detection of objects. The sensor must be mounted in an EHEDG-approved mounting clip, such as the sensor screw connection BF-pms/A1 for a EHEDG-compliant use.

Installation

- Assemble the sensor and its hygienic D12 sensor screw connection BF-pms/A1 or an equivalent sensor mounting clip at the installation location.
- Pull sensor cable through the sensor gland, connect it to the M8 sensor plug, see fig. 1.
- Push the sensor with its shaft into the sensor screw connection BF-pms/A1 and adjust (see figure 3-5). Tighten with lock nut (maximum tightening torque 12 Nm).

determine whether the sensor (stainless steel, FKM, PTFE) is resistant to them. Cleaning is permitted up to a cleaning temperature of 85°C. Do not use a high-pressure cleaner to clean the sensor. Caking of the sensor membrane must not be removed with sharp objects. The sensor membrane must not be damaged.

from the screw connection (see figure 5).

- The sealing ring has to fill space between D12 sensor shaft and cap nut. Sealing ring should not to be pressed out excessively from the shaft gland.

Operating Instructions Ultrasonic sensor with one analogue output

- pms-15/CI/A1 pms-15/CU/A1
- pms-25/CI/A1 pms-25/CU/A1
- pms-35/CI/A1 pms-35/CU/A1
- pms-100/CI/A1 pms-100/CU/A1

Sensor adjustment with Teach-in procedure

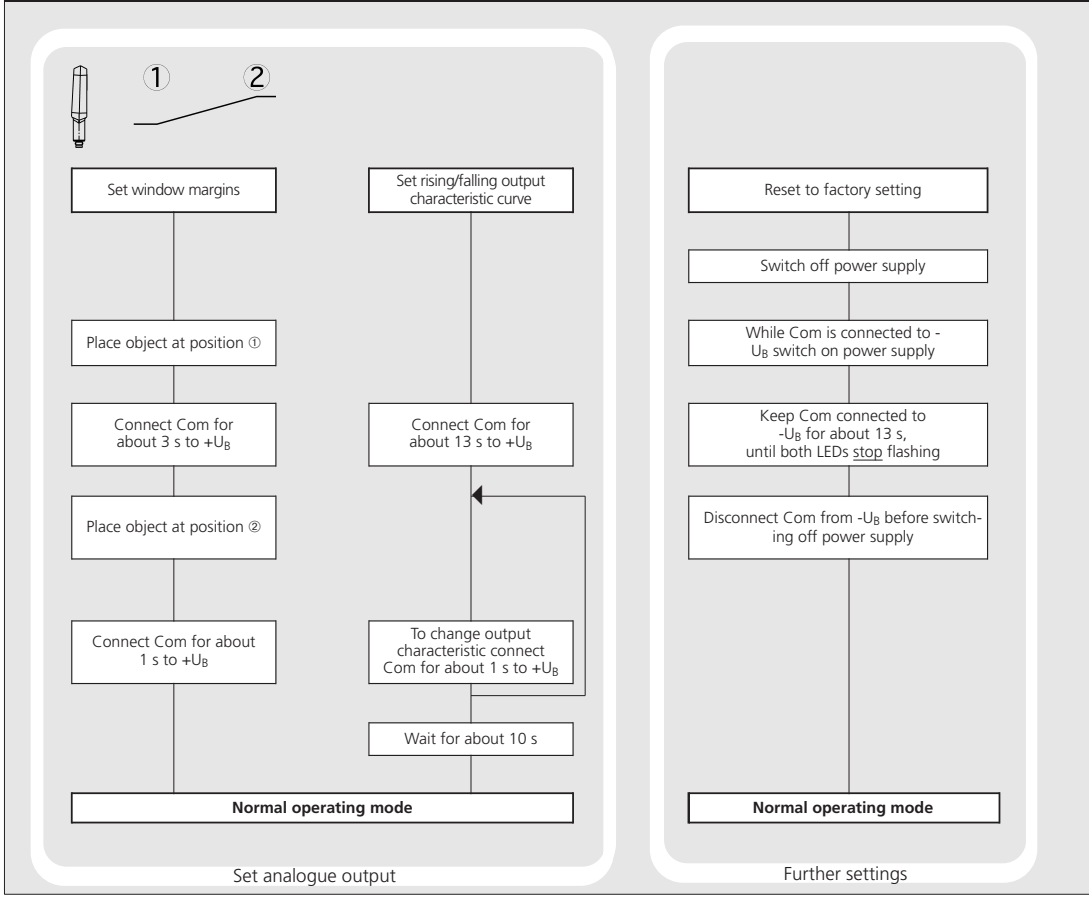

Start-Up

- Connect the power supply.
- Carry out the sensor adjustment with LinkControl or alternatively Teach-in procedure in accordance with the diagram.

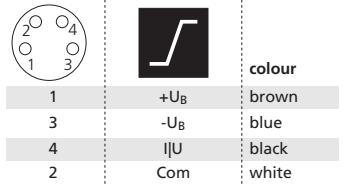

Fig. 1: Pin assignment with view onto sensor plug and colour coding of the microsonic connection cable

Factory Setting

- Rising analogue characteristic curve between the blind zone and the operating range.

Maintenance

microsonic sensors are maintenance-free. For cleaning in areas with hygienic requirements, access to the sensor must be guaranteed from all sides. The pms sensor is ECOLAB certified. The listed cleaning agents (see ECOLAB certificate) can be used to clean the sensors. Other cleaning agents must be tested first before usage in order to

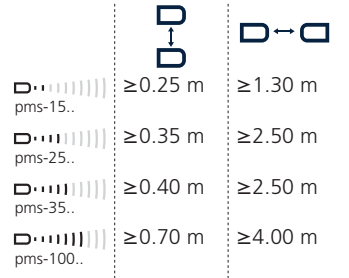

Fig. 2: Assembly distances to avoid a mutual influence of the sensors

Notes

- The sensors of the pms family have a blind zone. Within this zone a distance measurement is not possible.
- If several pms sensors are operated in a small space, the minimum mounting for parallel or opposite arrangement of the sensors shown in figure 2 must be maintained.
- The pms sensors are equipped with an internal temperature compensation. Due to the sensors self heating, the temperature compensation reaches its optimum working-point after approx. 45 seconds of operation.
- The sensor can be reset to its factory setting (see »Further settings«).
- For Teach-in procedure when using the LinkControl adapter (optional accessory) the additional adapter 5G/M12-4G/M12/M8 is needed.
- If the sensor is cleaned wet, all surfaces must be inclined at least 3° from the horizontal alignment so that the cleaning agents can run off completely (see fig. 3-5). There is a risk that condensate or dripping water might drip from the sensor and mounting brackets into the product area.
- The D12 adapter shaft of the pms sensor has to stick out at least 6 mm

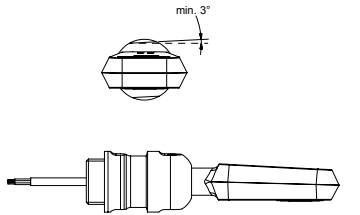

Fig. 3: pms sensor D12-adapter shaft with sensor screw connection BF-pms/A1, all surfaces must be inclined at least 3°.

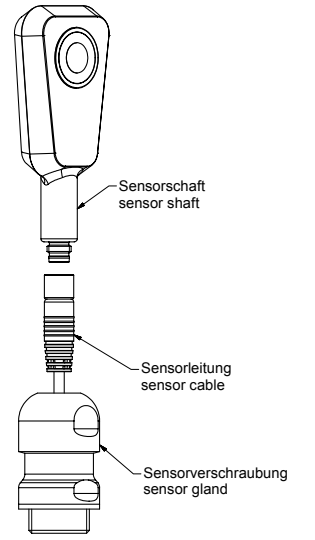
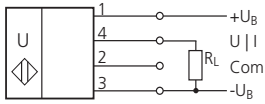

Fig. 4: Mounting of pms sensor with sensor screw connection BF-pms/A1

Technical data



1 analogue output

blind zone
operating range
maximum range
angle of beam spread
transducer frequency
resolution

20 mm
150 mm
250 mm
See detection zone
380 kHz
0.069 mm

reproducibility
accuracy

± 0.15 %
± 1 % (Temperature drift internal compensated)

detection zones

The dark grey areas are determined with a round bar and indicate the typical operating range of a sensor. In order to obtain the light grey areas, a plate (100 x 100 mm) is introduced into the beam spread from the side. In doing so, the optimum angle between plate and sensor is always employed. This therefore indicates the maximum detection zone of the sensor. It is not possible to evaluate ultrasonic reflections outside this area.

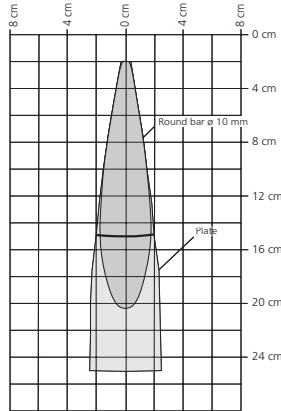

no-load current consumption
operating voltage ripple
housing

< 40 mA
±10 %
stainless steel 1.4404/316L;
ultrasonic transducer: PTFE, FKM

ECOLAB

EHDG

yes, TYPE EL CLASS I AUX

class of protection to EN 60 529

IP 66, IP 67, IP 68

norm conformity

EN 60947-5-2

type of connection
controls
programmable

4-pin M8 initiator plug
Teach-in via pin 2 (Com)
Teach-in, LinkControl

cleaning temperature
operating temperature
storage temperature

to +85°C
-25°C to +70°C
-40°C to +85°C

weight

140 g

response time 1)

24 ms

time delay before availability 1)

< 300 ms

analogue output 4-20 mA
operating voltage UB

$R_L \leq 500 \Omega$, rising/falling characteristic
10 - 30 V DC for $R_L \leq 100 \Omega$,
20 - 30 V DC for $R_L > 100 \Omega$,
terminal reverse polarity protected

order no.

pms-15/CI/A1

analogue output 0-10 V

$R_L \geq 100 \text{ k}\Omega$, short circuit proof,
rising/falling characteristic

operating voltage UB

15 - 30 V DC, terminal reverse polarity protected

order no.

pms-15/CU/A1

1) Can be programmed with LinkControl

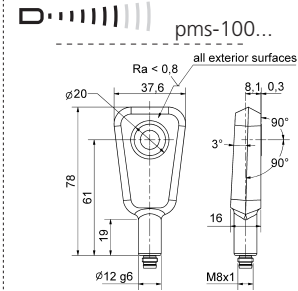
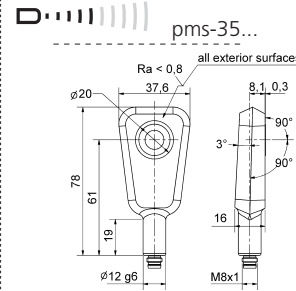
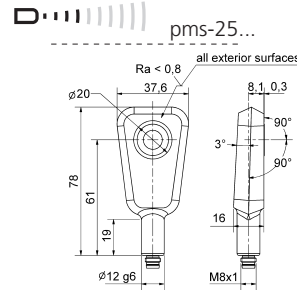
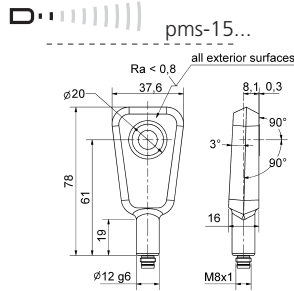

30 mm
250 mm
350 mm
See detection zone
320 kHz
0.069 mm to 0.10 mm, depending on the analogue window
± 0.15 %
± 1 % (Temperature drift internal compensated)

reproducibility
accuracy

± 0.15 %
± 1 % (Temperature drift internal compensated)

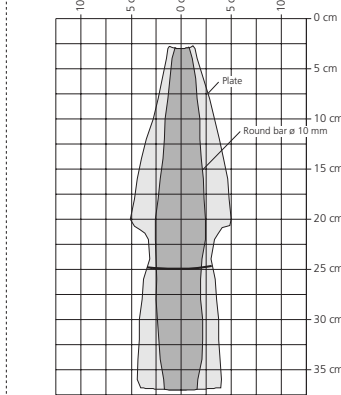

< 40 mA
±10 %
stainless steel 1.4404/316L;
ultrasonic transducer: PTFE, FKM

ECOLAB

EHDG

yes, TYPE EL CLASS I AUX

class of protection to EN 60 529

IP 66, IP 67, IP 68

norm conformity

EN 60947-5-2

type of connection
controls
programmable

4-pin M8 initiator plug
Teach-in via pin 2 (Com)
Teach-in, LinkControl

cleaning temperature
operating temperature
storage temperature

to +85°C
-25°C to +70°C
-40°C to +85°C

weight

140 g

response time 1)

24 ms

time delay before availability 1)

< 300 ms

analogue output 4-20 mA
operating voltage UB

$R_L \leq 500 \Omega$, rising/falling characteristic
10 - 30 V DC for $R_L \leq 100 \Omega$,
20 - 30 V DC for $R_L > 100 \Omega$,
terminal reverse polarity protected

order no.

pms-25/CI/A1

analogue output 0-10 V

$R_L \geq 100 \text{ k}\Omega$, short circuit proof,
rising/falling characteristic

operating voltage UB

15 - 30 V DC, terminal reverse polarity protected

order no.

pms-25/CU/A1

1) Can be programmed with LinkControl

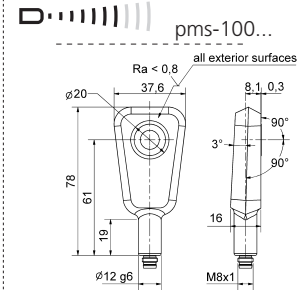
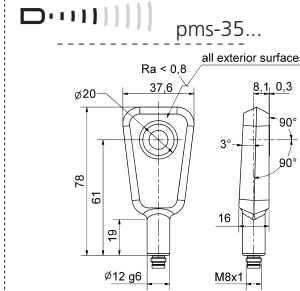

65 mm
350 mm
600 mm
See detection zone
400 kHz
0.069 mm to 0.17 mm, depending on the analogue window
± 0.15 %
± 1 % (Temperature drift internal compensated)

reproducibility
accuracy

± 0.15 %
± 1 % (Temperature drift internal compensated)

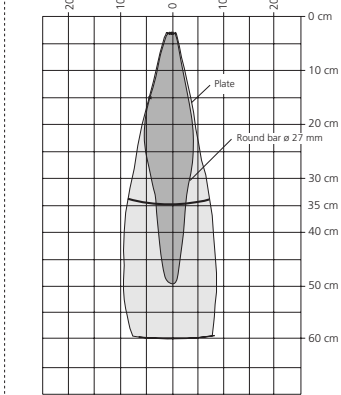

< 40 mA
±10 %
stainless steel 1.4404/316L;
ultrasonic transducer: PTFE, FKM

ECOLAB

EHDG

yes, TYPE EL CLASS I AUX

class of protection to EN 60 529

IP 66, IP 67, IP 68

norm conformity

EN 60947-5-2

type of connection
controls
programmable

4-pin M8 initiator plug
Teach-in via pin 2 (Com)
Teach-in, LinkControl

cleaning temperature
operating temperature
storage temperature

to +85°C
-25°C to +70°C
-40°C to +85°C

weight

140 g

response time 1)

48 ms

time delay before availability 1)

< 300 ms

analogue output 4-20 mA
operating voltage UB

$R_L \leq 500 \Omega$, rising/falling characteristic
10 - 30 V DC for $R_L \leq 100 \Omega$,
20 - 30 V DC for $R_L > 100 \Omega$,
terminal reverse polarity protected

order no.

pms-35/CI/A1

analogue output 0-10 V

$R_L \geq 100 \text{ k}\Omega$, short circuit proof,
rising/falling characteristic

operating voltage UB

15 - 30 V DC, terminal reverse polarity protected

order no.

pms-35/CU/A1

1) Can be programmed with LinkControl

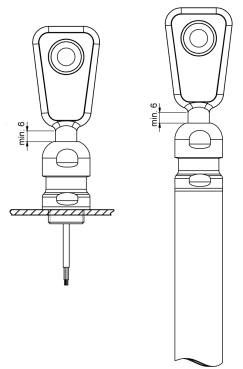

Fig. 5: Mounting of pms sensor with sensor screwconnection BF-pms/A1 mounted to machine part or to stainless steel tube D26.8 with internal thread M20x1.5

Mounting accessory

- D12 sensor screw connection BF-pms/A1

Accessory for programming

- LinkControl adapter LCA-2
- Adapter 5G/M12-4G/M12/M8



2014/30/EU

