



IO-Link

Product description

The lpc+ sensor offers a non-contact measurement of the distance to an object which must be positioned within the sensor's detection zone. The switched output is set conditional upon the adjusted detect distance, as an alternative to the set window margins, a distance proportional analogue signal is output.

Via the Teach-in procedure, the detect distance and operating mode can be adjusted. Two LEDs indicate operation and status of the switching and analogue outputs.

Operating Instructions

Ultrasonic proximity switch with one analogue output, one switched output and IO-Link

- lpc+15/CFI lpc+15/WK/CFI
- lpc+25/CFI lpc+25/WK/CFI
- lpc+35/CFI lpc+35/WK/CFI
- lpc+100/CFI lpc+100/WK/CFI

The lpc+ sensors are IO-Link-capable in accordance with IO-Link specification V1.1 and support Smart Sensor Profile like Digital Measuring Sensor.

Safety instructions

- Read the operating instructions prior to start-up.
- Connection, installation and adjustments may only be carried out by qualified staff.
- No safety component in accordance with the EU Machine Directive.

Use for intended purpose only

lpc+ ultrasonic sensors are used for non-contact detection of objects.

Installation

- Mount the sensor at the place of fitting.
- Connect a connection cable to the M12 device plug, see fig. 1.

Start-up

- Connect the power supply.
 - Carry out sensor adjustment in accordance with the diagram »Sensor adjustment with the Teach-in procedure«.
- Set operation-specific parameters can be locked against changes with the teach-in procedure »Switch on or off Teach-in + Synchronization«.

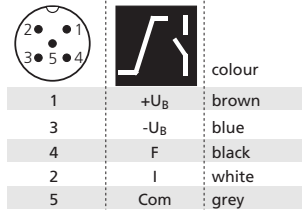

Fig. 1: Pin assignment with view onto sensor plug and colour coding of the microsonic connection cables

Factory setting

- Detect point operation
- Switched output on NOC
- Detect distance at operating range
- Multi-function input »Com« set

to »Teach-in«

- Filter at F01
- Filter strength at P00

Operating modes

Three operating modes are available:

- Operation with one detect point
The switched output is set when the object falls below the set detect point.
- Window mode
The switched output is set when the object is within the set window.
- Two-way reflective barrier
The switched output is set when the object is between sensor and fixed reflector.

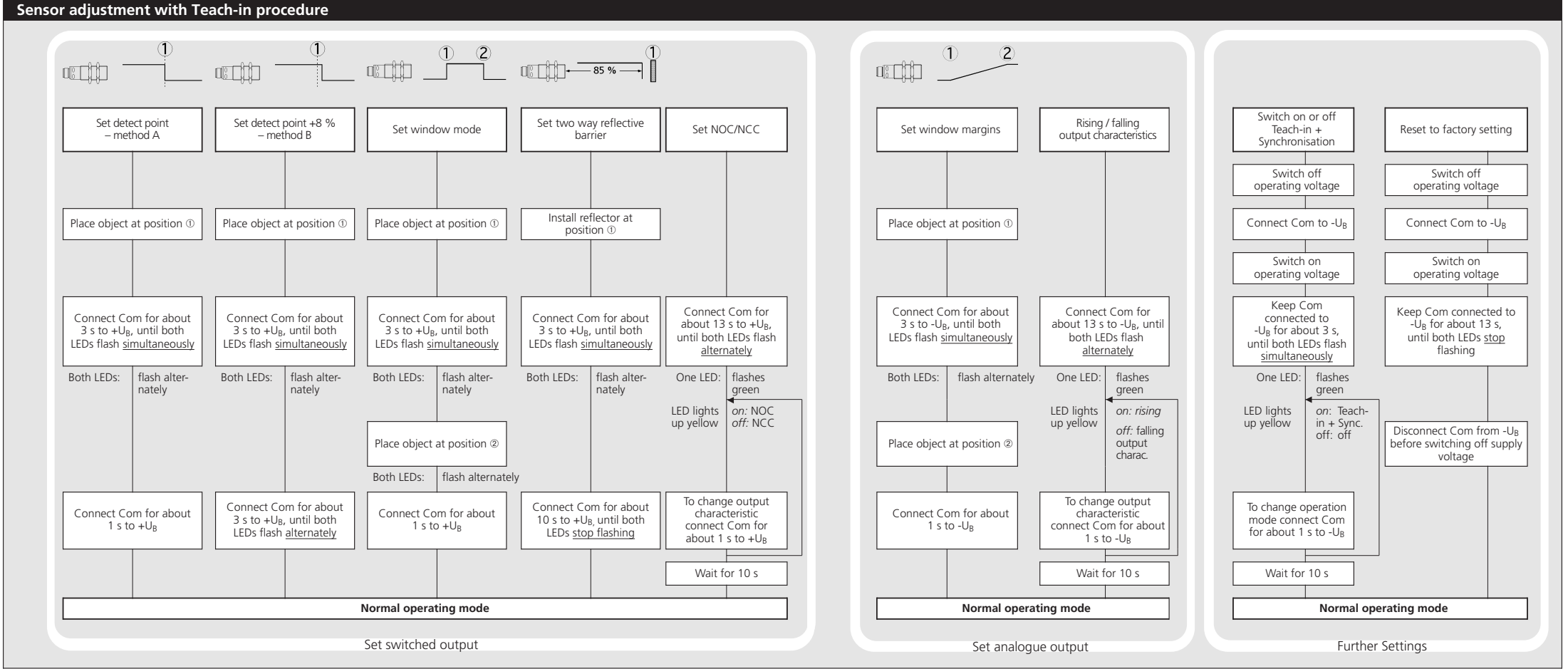

Synchronisation

If under multiple sensor operation the assembly distance falls below the values shown in fig. 2, the internal synchronisation should be used. For this purpose set the switched outputs of all sensors in accordance with the diagram »Sensor adjustment with the Teach-in procedure«.

Then switch-on the multi-function output »Com« (pin 5) to »Teach-in« and »synchronisation« (see »Further settings«).

Finally interconnect each pin 5 of the sensors to be synchronised.



	≥0.25 m	≥1.30 m
	≥0.35 m	≥2.50 m
	≥0.40 m	≥2.50 m
	≥0.70 m	≥4.00 m

Fig. 2: Assembly distances

Maintenance

microsonic sensors are maintenance-free. In case of excess caked-on dirt we recommend cleaning the white sensor surface.

Notes

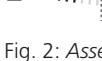
- The sensors of the lpc+ family have a blind zone, within which a distance measurement is not possible.
- The lpc+ sensors are equip-ped with an internal temperature compensation. Due to the sensors self heating, the temperature compensation reaches its optimum working-point after approx. 120 seconds of operation.
- In the normal operating mode, an illuminated yellow LED signals that the switched output is switched through.
- The lpc+ sensors have a push-pull switching output.

- In the »Two-way reflective barrier« operating mode, the object has to be within the range of 0-85 % of the set distance.
- In the »Set detect point – method A« Teach-in procedure the actual distance to the object is taught to the sensor as the detect point. If the object moves towards the sensor (e.g. with level control) then the taught distance is the level at which the sensor has to switch the output, see. fig. 3.
- If the object to be scanned moves into the detection area from the side, the »Set detect point +8 % – method B« Teach-in procedure should be used. In this way the switching distance is set 8 % further than the actual measured distance to the object. This ensures a reliable switching distance even if the height of the objects varies slightly, see fig. 3.

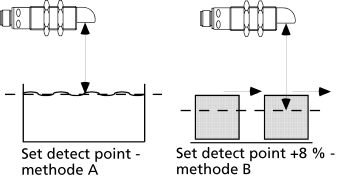
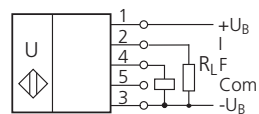

Fig. 3: Setting the detect point for different directions of movement of the object

- The sensor can be reset to its factory setting (see »Further settings«).
- Using the LinkControl adapter LCA-2 (optional accessory) and the LinkControl software for Windows, all Teach-in and additional sensor parameter settings can be optionally undertaken.
- The latest IODD file and informtations about start-up and configuration of lpc+ sensors with IO-Link, you will find online at: <https://www.microsonic.de/lpc+>



Technical data



Push-Pull output in pnp circuit

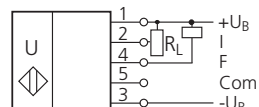

Push-Pull output in npn circuit

blind zone

operating range

maximum range

angle of beam spread

transducer frequency

resolution

reproducibility

detection zones

for different objects:
The dark grey areas represent the zone where it is easy to recognise the normal reflector (round bar). This indicates the typical operating range of the sensors. The light grey areas represent the zone where a very large reflector – for instance a plate – can still be recognized. The requirement here is for an optimum alignment to the sensor. It is not possible to evaluate ultrasonic reflections outside this area.

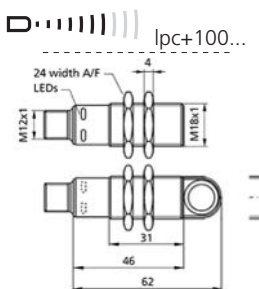
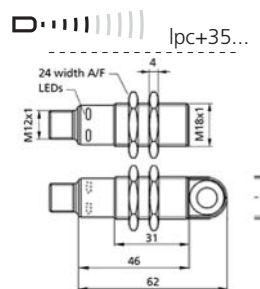
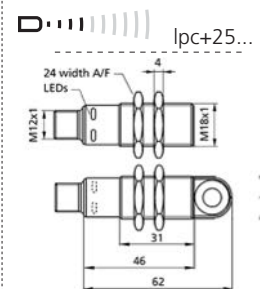
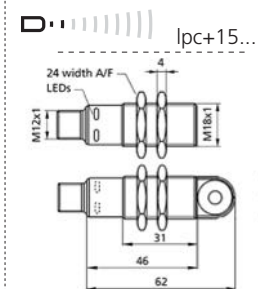

20 mm

150 mm

250 mm

see detection zone

380 kHz

0,1 mm

± 0.15 %

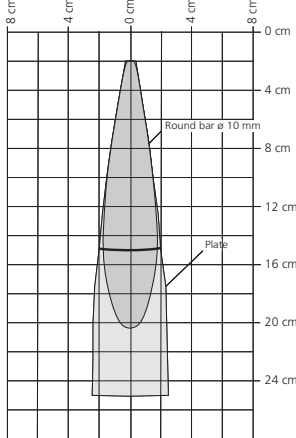

30 mm

250 mm

350 mm

see detection zone

320 kHz

0,1 mm

± 0.15 %

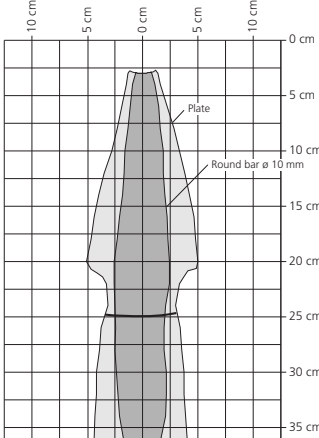

65 mm

350 mm

600 mm

see detection zone

400 kHz

0,1 mm

± 0.15 %

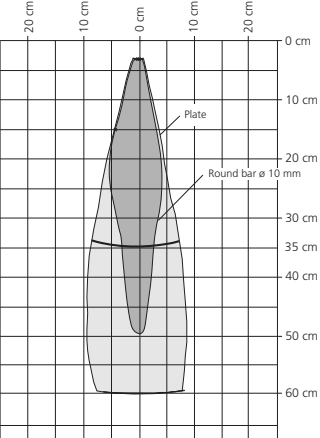

120 mm

1,000 mm

1,300 mm

see detection zone

200 kHz

0,1 mm

± 0.15 %

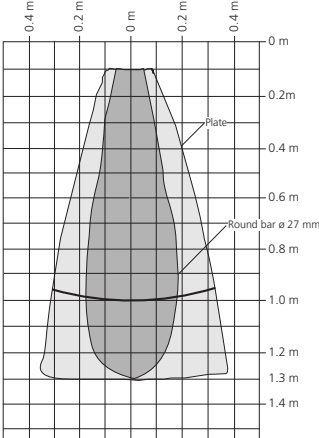

accuracy

± 1 % (temperature drift internally compensated)

operating voltage U_B

10 - 30 V DC, reverse polarity protection (Class 2)

voltage ripple

± 10 %

no-load current consumption

< 60 mA

housing

brass sleeve, nickel-plated, plastic parts: PBT; ultrasonic transducer: polyurethane foam, epoxy resin with glass content

max. tightening torque of nuts

15 Nm

class of protection per EN 60 529

IP 67

type of connection

5-pin M12 circular plug

controls

Teach-in via pin 5 (Com)

indicators

LED green (operation)

LED yellow (state of output)

programmable

Teach-in, LinkControl

synchronisation

internal synchronisation up to 10 sensors

operating temperature

-25°C to +70°C

storage temperature

-40°C to +85°C

switched output

Push-Pull, U_B -3 V, $-U_B$ +3 V, I_{max} = 100 mA

switchable NOC/NCC, short-circuit-proof

switching hysteresis¹⁾

2 mm

switching frequency¹⁾

25 Hz

response time¹⁾

32 ms

time delay before availability¹⁾

< 300 ms

analogue output 4-20mA

$R_L \geq 100$ k Ω , rising/falling characteristic

operating voltage U

$R_L \geq 100$ k Ω , at $U_B \geq 15$ V, short-circuit-proof

terminal reverse polarity protected, Class 2

norm conformity

EN 60947-5-2

order no. directly radiating

lpc+15/CFI

weight

35 g

order no. angular head

lpc+15/WK/CFI

weight

40 g

1) Can be programmed with LinkControl

± 1 % (temperature drift internally compensated)

10 - 30 V DC, reverse polarity protection (Class 2)

± 10 %

< 60 mA

brass sleeve, nickel-plated, plastic parts: PBT; ultrasonic transducer: polyurethane foam, epoxy resin with glass content

15 Nm

IP 67

5-pin M12 circular plug

Teach-in via pin 5 (Com)

LED green (operation)

LED yellow (state of output)

Teach-in, LinkControl

internal synchronisation up to 10 sensors

-25°C to +70°C

-40°C to +85°C

Push-Pull, U_B -3 V, $-U_B$ +3 V, I_{max} = 100 mA

switchable NOC/NCC, short-circuit-proof

3 mm

25 Hz

32 ms

< 300 ms

$R_L \geq 100$ k Ω , short rising/falling characteristic

$R_L \geq 100$ k Ω , at $U_B \geq 15$ V, short-circuit-proof

terminal reverse polarity protected, Class 2

EN 60947-5-2

lpc+25/CFI

35 g

lpc+25/WK/CFI

40 g

± 1 % (temperature drift internally compensated)

10 - 30 V DC, reverse polarity protection (Class 2)

± 10 %

< 60 mA

brass sleeve, nickel-plated, plastic parts: PBT; ultrasonic transducer: polyurethane foam, epoxy resin with glass content

15 Nm

IP 67

5-pin M12 circular plug

Teach-in via pin 5 (Com)

LED green (operation)

LED yellow (state of output)

Teach-in, LinkControl

internal synchronisation up to 10 sensors

-25°C to +70°C

-40°C to +85°C

Push-Pull, U_B -3 V, $-U_B$ +3 V, I_{max} = 100 mA

switchable NOC/NCC, short-circuit-proof

5 mm

12 Hz

64 ms

< 300 ms

$R_L \geq 100$ k Ω , rising/falling characteristic

$R_L \geq 100$ k Ω , at $U_B \geq 15$ V, short-circuit-proof

terminal reverse polarity protected, Class 2

EN 60947-5-2

lpc+35/CFI

35 g

lpc+35/WK/CFI

40 g

± 1 % (temperature drift internally compensated)

10 - 30 V DC, reverse polarity protection (Class 2)

± 10 %

< 60 mA

brass sleeve, nickel-plated, plastic parts: PBT; ultrasonic transducer: polyurethane foam, epoxy resin with glass content

15 Nm

IP 67

5-pin M12 circular plug

Teach-in via pin 5 (Com)

LED green (operation)

LED yellow (state of output)

Teach-in, LinkControl

internal synchronisation up to 10 sensors

-25°C to +70°C

-40°C to +85°C

Push-Pull, U_B -3 V, $-U_B$ +3 V, I_{max} = 100 mA

switchable NOC/NCC, short-circuit-proof

20 mm

10 Hz

80 ms

< 300 ms

$R_L \geq 100$ k Ω , rising/falling characteristic

$R_L \geq 100$ k Ω , at $U_B \geq 15$ V, short-circuit-proof

terminal reverse polarity protected, Class 2

EN 60947-5-2

lpc+100/CFI

35 g

lpc+100/WK/CFI

40 g