



Product Description
The nano sensor offer a non-contact measurement of the distance to an object which must be positioned within the sensor's detection zone. The switching output is set conditional upon the adjusted detect distance. Via the Teach-in procedure, the detect distance and operating mode can be adjusted.

IO-Link
The nano sensor is IO-Link-capable in accordance with IO-Link specification V1.1 and supports Smart Sensor Profile like Digital Measuring Sensor. The sensor can be monitored and parameterized via IO-Link. Detailed information on parameterisation via IO-Link can be found in the sensor's IO-Link data sheet at microsonic.de/en/nano.

Operation Manual

Ultrasonic proximity switch with one switching output and IO-Link

nano-15/CF
nano-24/CF

Safety Notes

- Read the operation manual prior to start-up.
- Connection, installation and adjustment works should be carried out by expert personnel only.
- No safety component in accordance with the EU Machine Directive, use in the area of personal and machine protection not permitted

Proper Use
nano ultrasonic sensors are used for non-contact detection of objects.

Installation

- Mount the sensor at the installation site.
- Connect a connection cable to the M12 device plug, see Fig. 1.
- If necessary, use the alignment assistance (see »Using the Alignment Assistance«).

Pin	microsonic notation	IO-Link notation	IO-Link Smart Sensor Profile	colour
1	+U _B	L+	SSC1	brown
2	Com	NC		white
3	-U _B	L-		blue
4	F	C/Q		black

Fig. 1: Pin assignment with view onto sensor plug, IO-Link notation and colour coding of the microsonic connection cables.

Start-up

- Connect the power supply.
- Set the parameters of the sensor by using the Teach-in procedure, see Diagram 1.

Factory Settings
nano sensors are delivered factory made with the following settings:

- Switching point operation.
- Switching output on NOC.
- Detect distance:
nano-15/CF: 150 mm
nano-24/CF: 250 mm

- Filter at F01
- Filter strength at P00

Operating Modes
Three operating modes are available for the switching output:

- Operation with one switching point**
The switching output is set when the object falls below the set switching point.

- Window mode**
The switching output is set when the object is within the set window limits.
- Two-way reflective barrier**
The switching output is set when the object is between sensor and fixed reflector.

	Window mode	Two-way reflective barrier
nano-15...	≥0.25 m	≥1.30 m
nano-24...	≥0.25 m	≥1.40 m

Fig. 2: Minimal assembly distances

Synchronisation
If the assembly distance of multiple sensors falls below the values shown in Fig. 2, the internal synchronisation should be used (»Teach-in + sync« must be switched on, see Diagram 1). For this purpose set the switching outputs of all sensors in accordance with Diagram 1. Finally interconnect each pin 2 of the sensors to be synchronised.

Maintenance
microsonic sensors are maintenance-free. In case of excess caked-on dirt we recommend cleaning the white sensor surface.

Diagram 1: Set sensor parameters via the Teach-in procedure

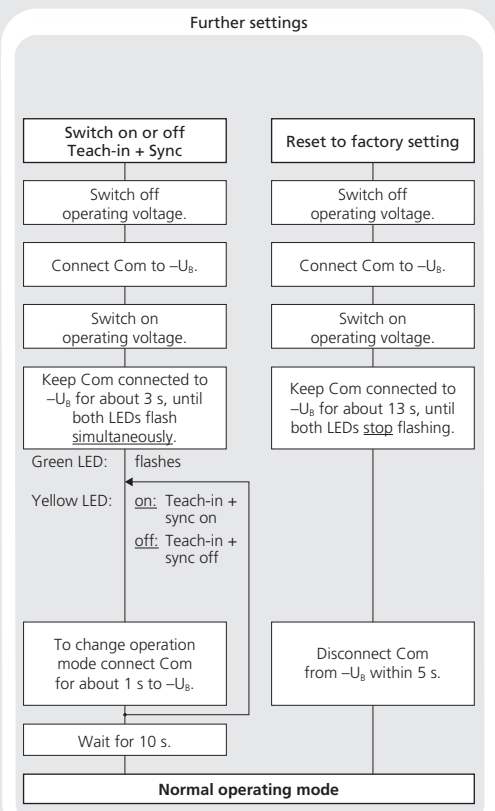
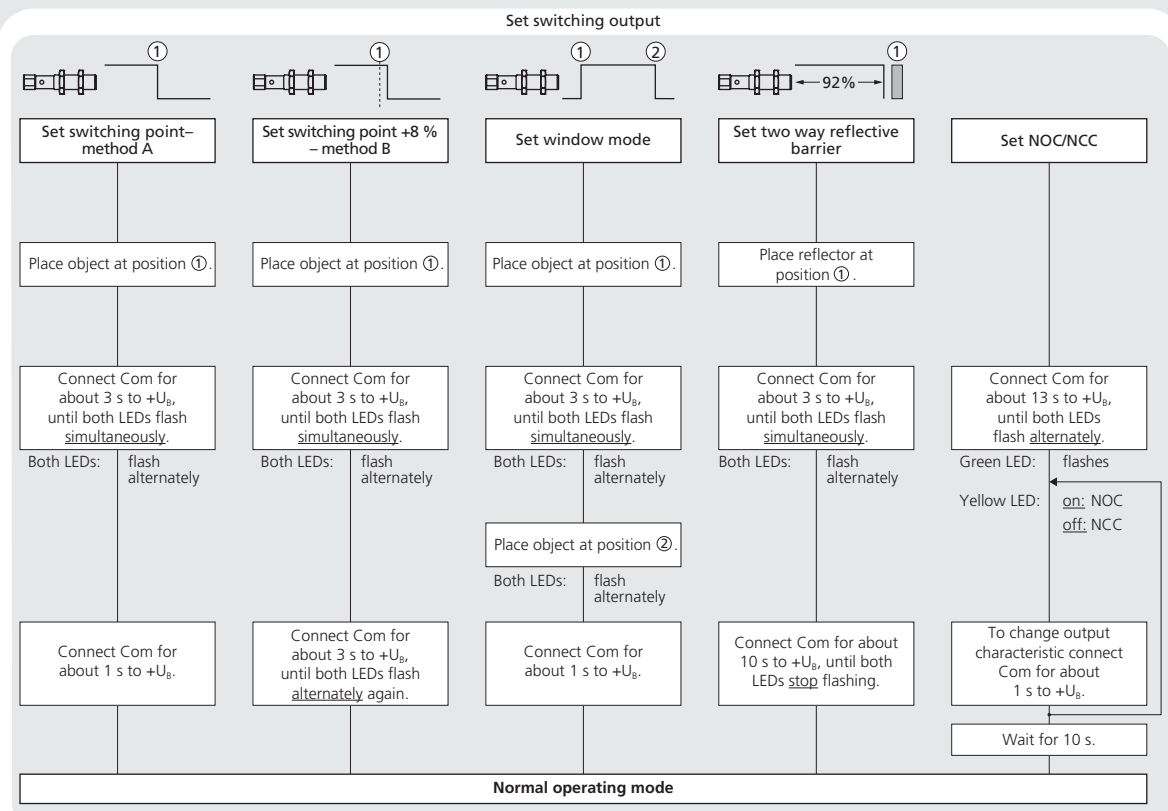

Technical data

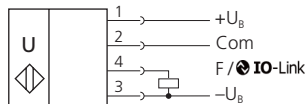

1 Push-Pull output in pnp circuit

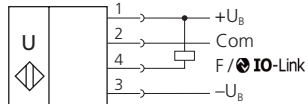

1 Push-Pull output in npn circuit

nano-15...

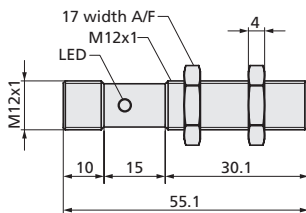

nano-24...

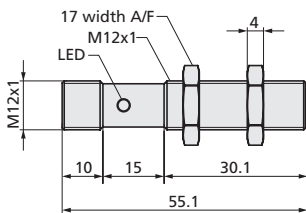

blind zone: 20 mm
operating range: 150 mm
maximum range: 250 mm
angle of beam spread: see detection zone
transducer frequency: 380 kHz
resolution: 0.1 mm
reproducibility: ±0.15 %
detection zone

for different objects:
 The dark grey areas represent the zone where it is easy to recognise the normal reflector (round bar). This indicates the typical operating range of the sensors. The light grey areas represent the zone where a very large reflector - for instance a plate - can still be recognised.
 The requirement is an optimal alignment to the sensor. It is not possible to evaluate ultrasonic reflections outside this area.

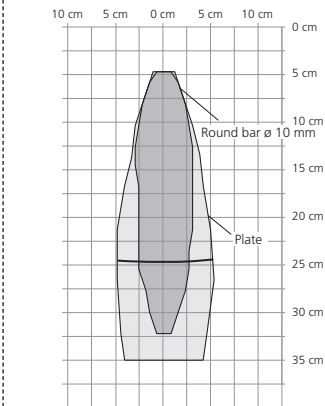
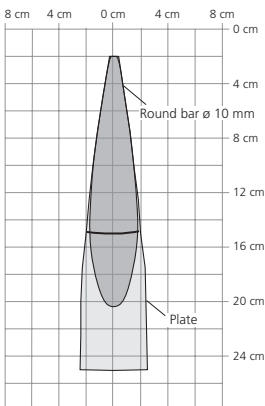

accuracy: ±1 % (temperature drift internally compensated, may be deactivated ¹⁾, 0.17%/K without compensation)

operating voltage U_B: 10 to 30 V DC, reverse polarity protection (Class 2)

voltage ripple: ±10 %

no-load current consumption: <30 mA

housing: brass sleeve, nickel-plated, plastic parts: PBT; ultrasonic transducer: polyurethane foam, epoxy resin with glass content

max. tightening torque of nuts: 1 Nm

class of protection per EN 60529: IP 67

norm conformity: EN 60947-5-2

type of connection: 4-pin M12 circular plug

controls: Teach-in via pin 2

scope of settings: Teach-in, LinkControl, IO-Link

IO-Link: V1.1

indicators: 2 LEDs

synchronisation: internal synchronisation up to 10 sensors

operating temperature: -25 to +70 °C

storage temperature: -40 to +85 °C

weight: 15 g

switching hysteresis ¹⁾: 2 mm

switching frequency ²⁾: 25 Hz

response time ²⁾: 32 ms

time delay before availability: <300 ms

order no.: nano-15/CF

switching output: Push-Pull, U_B-3 V, -U_B+3 V, I_{max} = 100 mA switchable NOC/NCC, short-circuit-proof

¹⁾ Can be programmed via LinkControl and IO-Link.

²⁾ With LinkControl and IO-Link, the selected filter setting influences the switching frequency and response time.

blind zone: 40 mm
operating range: 240 mm
maximum range: 350 mm
angle of beam spread: see detection zone
transducer frequency: 500 kHz
resolution: 0.1 mm
reproducibility: ±0.15 %
detection zone

for different objects:
 The dark grey areas represent the zone where it is easy to recognise the normal reflector (round bar). This indicates the typical operating range of the sensors. The light grey areas represent the zone where a very large reflector - for instance a plate - can still be recognised.
 The requirement is an optimal alignment to the sensor. It is not possible to evaluate ultrasonic reflections outside this area.

for different objects:
 The dark grey areas represent the zone where it is easy to recognise the normal reflector (round bar). This indicates the typical operating range of the sensors. The light grey areas represent the zone where a very large reflector - for instance a plate - can still be recognised.
 The requirement is an optimal alignment to the sensor. It is not possible to evaluate ultrasonic reflections outside this area.

accuracy: ±1 % (temperature drift internally compensated, may be deactivated ¹⁾, 0.17%/K without compensation)

operating voltage U_B: 10 to 30 V DC, reverse polarity protection (Class 2)

voltage ripple: ±10 %

no-load current consumption: <40 mA

housing: brass sleeve, nickel-plated, plastic parts: PBT; ultrasonic transducer: polyurethane foam, epoxy resin with glass content

max. tightening torque of nuts: 1 Nm

class of protection per EN 60529: IP 67

norm conformity: EN 60947-5-2

type of connection: 4-pin M12 circular plug

controls: Teach-in via pin 2

scope of settings: Teach-in, LinkControl, IO-Link

IO-Link: V1.1

indicators: 2 LEDs

synchronisation: internal synchronisation up to 10 sensors

operating temperature: -25 to +70 °C

storage temperature: -40 to +85 °C

weight: 15 g

switching hysteresis ¹⁾: 3 mm

switching frequency ²⁾: 20 Hz

response time ²⁾: 40 ms

time delay before availability: <300 ms

order no.: nano-24/CF

switching output: Push-Pull, U_B-3 V, -U_B+3 V, I_{max} = 100 mA switchable NOC/NCC, short-circuit-proof

Using the Alignment Assistance

With the internal alignment assistance the sensor can be optimally aligned to the object during installation. To do this, proceed as follows (see Fig. 3):

- ➔ Mount the sensor loosely at the place of mounting so that it can still be moved.
- ➔ Connect Com to +U_B shortly. The green LED flashes. The faster the LED flashes, the stronger the received signal.
- ➔ Point the sensor at different angles to the object for about 10 seconds so that the sensor can determine the maximum signal level. Align the sensor until the green LED shines constantly.
- ➔ Screw the sensor in this position.
- ➔ Connect Com to +U_B shortly (or wait approx. 120 s) to exit the alignment assistance. The yellow LED flashes 2x.

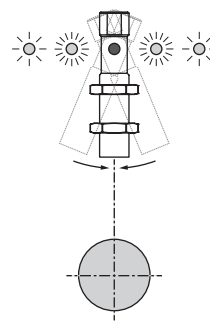

Fig. 3: Align the sensor optimally

Notes

- Pin 2 (Com) of the sensor may only be connected during Teach-in procedures or for synchronisation.
- The sensors of the nano family have a blind zone. Within this zone a distance measurement is not possible.
- The nano sensors are equipped with an internal temperature compensation. Due to the sensors self heating, the temperature compensation reaches its optimal working point after approx. 45 seconds of operation.
- The nano sensors have a push-pull switching output.
- In the normal operating mode, an illuminated yellow LED signals that the status of the switching output is high. If the green LED flashes, the sensor is in IO-Link mode.
- In the »Two-way reflective barrier« operating mode, the object has to be within the range of 0 to 92 % of the set distance.
- In the »Set switching point - method A« Teach-in procedure the actual distance to the object is taught to the sensor as the switching point. If the object moves towards the sensor (e.g. with level control) then the taught distance is the level at which the sensor has to switch the output, see Fig. 4.
- If the object to be scanned moves into the detection zone from the side, the »Set switching point +8 % - method B« Teach-in procedure should be used. In this way the switching distance is set 8 % further than the actual measured distance to the object. This ensures a reliable switching distance even if the height of the objects varies slightly, see Fig. 4.

- Using the LinkControl adapter LCA-2 (optional accessory) and the LinkControl software for Windows®, all Teach-in and additional sensor parameter settings can be optionally adjusted. To connect the nano sensor to the LCA-2 adapter the 5G/M12-4G/M12/M8 adapter is required.

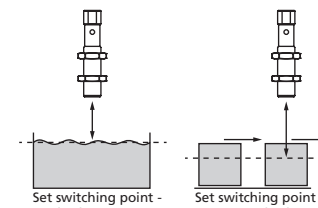

Fig. 4: Setting the switching point for different directions of movement of the object

- The sensor can be reset to its factory setting (see Diagram 1).
- The nano sensor can be blocked against changes in the sensor via function »Switch on or off Teach-in + sync«, see Diagram 1.
- The latest IODD file and informations about start-up and configuration of nano sensors via IO-Link, you will find online at: www.microsonic.de/en/nano

