



IO-Link accompanying document for

nano-15/CF
nano-24/CF

1	Contents of the IO-Link accompanying document.....	3
2	IO-Link in detail.....	3
3	Description of the sensor	4
4	IO-Link data of the sensor.....	4
4.1	Process data	5
4.2	Measurement data channel description	5
4.3	Switch signal channel.....	6
5	Switching mode and operating modes	7
6	Setting the sensor with Teach-in	8
6.1	Teach-in via pin 2 on the sensor	8
6.2	Teach-in parameters via IO-Link.....	8
6.2.1	Teach-in via IO-Link	9
7	Further settings via IO-Link.....	10
7.1	Synchronisation and Multiplex mode	10
7.2	Sound field width & Sensitivity	12
7.3	Measurement configuration	12
7.4	Filter	13
7.5	Temperature compensation	13
7.5.1	Temperature compensation diagnosis.....	13
7.6	LED	14
7.7	Returning to factory setting.....	14
7.8	Device Access Locks	14
7.9	Identification	15
7.10	Device status.....	15
7.11	Events.....	16
7.12	Data storage	16
7.13	Block parametrisation.....	16
7.14	Parameter access and error codes.....	17
8	Appendix: Overview IO-Link data	18

1 Contents of the IO-Link accompanying document

This IO-Link accompanying document guides the user during start-up and parametrisation of the ultrasonic sensor. It does **not** replace the operating manual enclosed with the ultrasonic sensor. The safety notes and descriptions of installation and start-up contained in the operating manual require compliance.

2 IO-Link in detail

IO-Link is a fieldbus-independent, manufacturer-independent and neutral communication standard which enables seamless communication through all levels of the system architecture down to the sensor.

The IO-Link interface provides direct access to process, service and diagnostic data. The sensor can be parametrised during operation.

Structure of an IO-Link system

An IO-Link system consists of IO-Link devices – usually sensors, actuators or combinations thereof – and a standard 3-wire sensor/actuator cable and an IO-Link master.

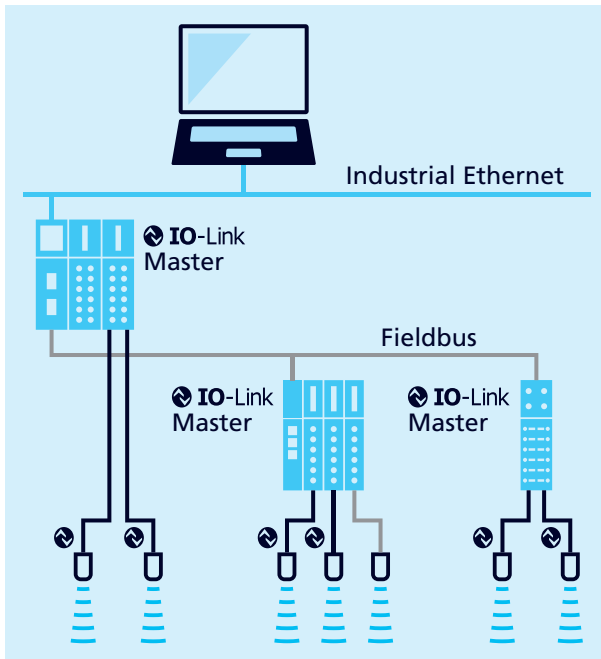

Fig. 1: Structure of an IO-Link system

IODD description file

Each IO-Link-capable sensor has a device-specific description file, the IODD (IO Device Description). The IODD contains parameters in a standardised form and can describe several sensor versions. The parameters included are:

- › Communication properties
- › Device parameters with permissible and pre-set values
- › Identification, process and diagnostic data
- › Device data
- › Text description
- › Product image
- › Manufacturer's logo

The current IODD library and information on start-up and parametrisation can be downloaded here: [microsonic.de/Service/IO-Link IODD Library](http://microsonic.de/Service/IO-Link%20IODD%20Library).

3 Description of the sensor

Ultrasonic proximity switch with one switching output and IO-Link interface

- › nano-15/CF
- › nano-24/CF

The nano sensor offer a non-contact measurement of the distance to an object which must be positioned within the sensor's detection zone. The switching output is set conditional upon the adjusted detect distance. Via the Teach-in procedure, the detect distance and operating mode can be adjusted.

The nano sensor is IO-Link-capable in accordance with specification V1.1 and supports smart sensor profiles such as measuring and switching sensors. The sensor can be monitored and parametrised via IO-Link.



Fig. 2: nano sensor family

4 IO-Link data of the sensor

The nano sensors are IO-Link-capable in accordance with specification 1.1. The sensor has an IO-Link communication interface on pin 4 (see Fig. 3).

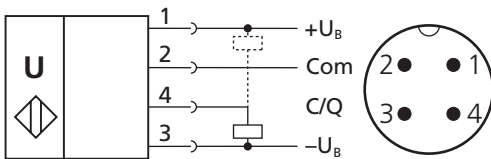

Fig. 3: Connection diagram of the nano sensor

Device Profile

0x0001	Generic Profiled Sensor
0x000A	Measuring Sensor

Function class

0x8000	Device Identification
0x8001	Switching Signal Channel
0x8003	Device Diagnosis
0x8004	Teach Channel
0x800A	Measurement Data Channel, (standard resolution)

Physical layer

Vendor Name	microsonic GmbH
Vendor ID	419 (0x01a3)
IO-Link Revision	1.1.2
Transmission Rate	38400 bit/s (COM2)
Process data length	32 Bit PDI
IO-Link port type	A (<200 mA)
SIO mode	Yes
Smart sensor profile	Yes
Block Parameter	Yes
Data Storage	Yes

Table 1: IO-Link sensor data

	nano-15	nano-24
Device ID	85 (0x000055)	86 (0x000056)
Product name	nano-15/CF	nano-24/CF
Product ID	34020	34021
Minimum Cycle Time	8 ms	10 ms

4.1 Process data

The process data is cyclically transmitted data. The process data length of the nano sensors is 4 bytes.

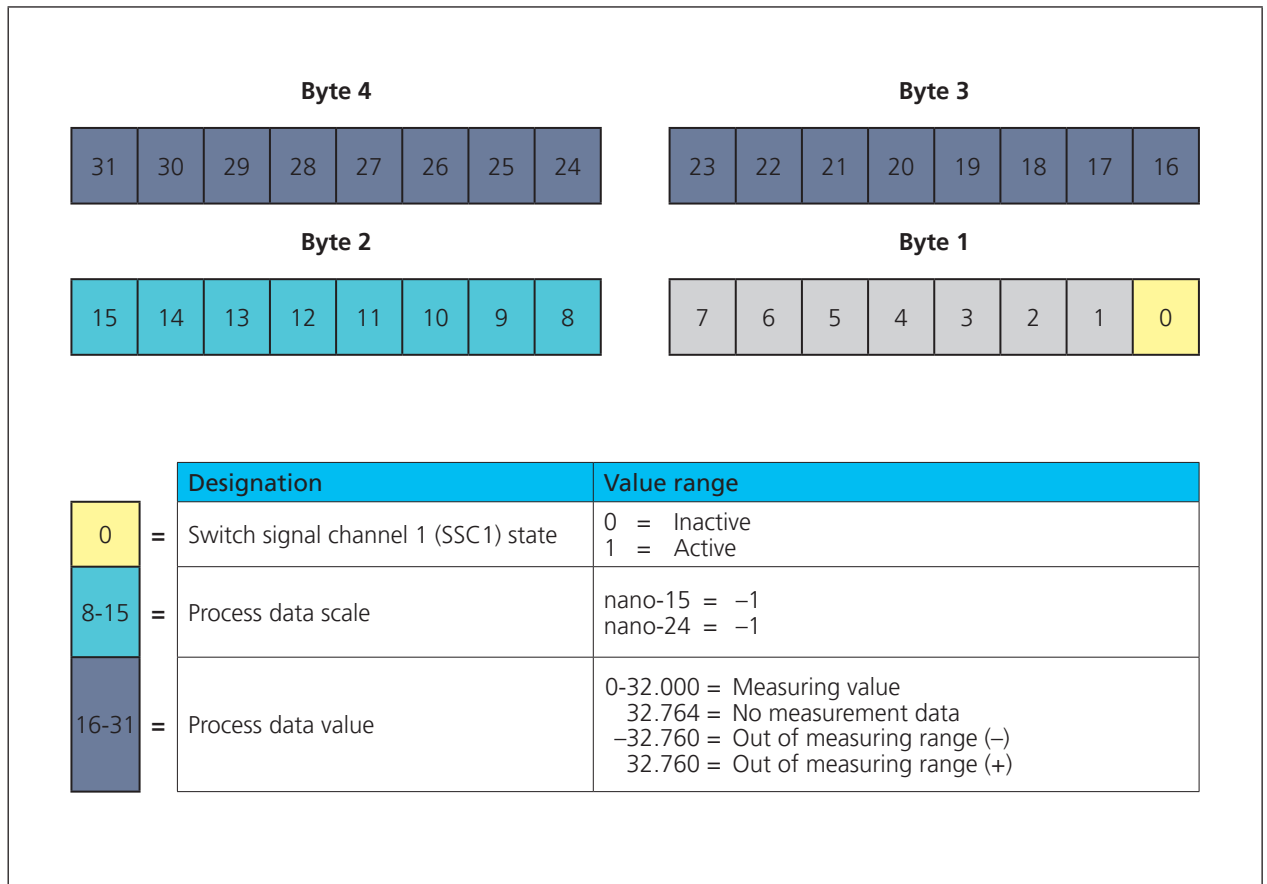

Fig. 4: Process data structure

4.2 Measurement data channel description

Lower limit

The »Lower limit« is the smallest measured value that the sensor can output

Upper limit

The »Upper limit« is the largest measured value that the sensor can output.

Unit code

The measured value has no dimension. The unit code is based on the official IO-Link unit code: 1013 = [mm]

Scale

The scaling of the process data. The specified measured value of the sensor is calculated from

$$\text{Process data value} \times 10^{(\text{scale})} \times [\text{unit code}] = \text{measuring value in mm}$$

Example: $642 \times 10^{(-1)} \times [\text{mm}] = 64.2 \text{ mm}$

Table 2: IO-Link parameters – Measurement data channel description

Index	Sub-index	Designation	Format	Access	Factory setting	Value range	Resolution
16512	0	Measurement data channel description	Record				
	1	Lower limit	Int32	RO	nano-15 = 200 nano-24 = 400	200...600 400...1,200	0.1 mm 0.1 mm
	2	Upper limit	Int32	RO	nano-15 = 2,500 nano-24 = 3,500	2,500 3,500	0.1 mm 0.1 mm
	3	Unit code	UInt16	RO	nano-15 = 1013 nano-24 = 1013		
	4	Scale	Int8	RO	nano-15 = -1 nano-24 = -1		

4.3 Switch signal channel

The nano sensor has the switch signal channel SSC1 (SSC: Switch signal Channel). The switch signal channel contains the values for the switching points SP1 and SP2, the setting

of the switching output logic, the definition of the switching mode (see Chapter 5) and the values for the hysteresis.

Table 3: IO-Link parameters – SSC1: Switch signal channel 1

Switch signal channel	SSC1					
Designation	Index	Sub-index	Factory setting	Value range	Resolution	
SP1	60	1	nano-15 = 1,500 nano-24 = 2,500	200...2,500 400...3,500	0.1 mm 0.1 mm	
SP2	60	2	nano-15 = 1,700 nano-24 = 2,800	200...2,500 400...3,500	0.1 mm 0.1 mm	
Logic	61	1	0	0 = High active 1 = Low active		
Mode	61	2	1	0 = Deactivated 1 = Single point (SP1: switching point) 2 = Window (SP1, SP2: window mode) 3 = Two point (SP1, SP2: hysteresis mode) 128 = Single point + set point offset (SP1: switching point + offset) 129 = Window ± set point offset (SP1: two way reflective barrier)		
Hysteresis	61	3	nano-15 = 20 nano-24 = 30	10...2,300 10...3,100	0.1 mm 0.1 mm	
Switch-on delay	100	1	0	0...255	0.1 second	
Switch-off delay	100	2	0	0...255	0.1 second	
Set point offset	100	3	8	2...20	1 %	

5 Switching mode and operating modes

Various switching modes can be set via the IO-Link parameter »Mode«. The corresponding switching mode results from the application. The following section lists the available operating modes or switching modes.

Note: If the switching mode is deactivated, the switching output remains in the inactive state regardless of the measured distance value.

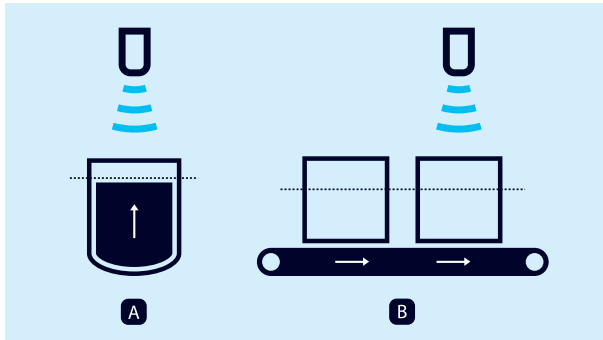

Fig. 5: Switching point mode of the sensor, Method A and B

Operating mode: Switching point (Method A)

- › Switching mode: Single point
- › Parameter: Index 61 Subindex 2 = 1, see chap. 4.3

The switching output is set if the distance measured to an object is smaller than the set switching point (see Fig. 6). The actual distance to the object during Teach-in is also the switching point. A typical application is filling level measurement, where the ultrasonic sensor detects the filling level vertically from above during the filling process (see Fig. 5, left). In this case, the taught-in switching point can correspond to the maximum filling level, for example.

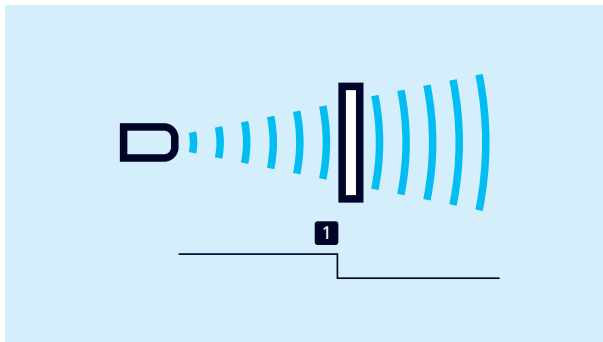

Fig. 6: Switching point (Method A), single point

Operating mode: Switching point (Method B)

- › Switching mode: Single point + set point offset
- › Parameter: Index 61 Subindex 2 = 128, see chap. 4.3

The switching output is set if the distance measured to an object is smaller than the set switching point plus an offset (see Fig. 7). This method is recommended for objects that enter the sound field from the side (see Fig. 5, right). A switching point 8 % greater than the actual distance to the object is set. This ensures a stable switching behaviour with minor height fluctuations of the objects.

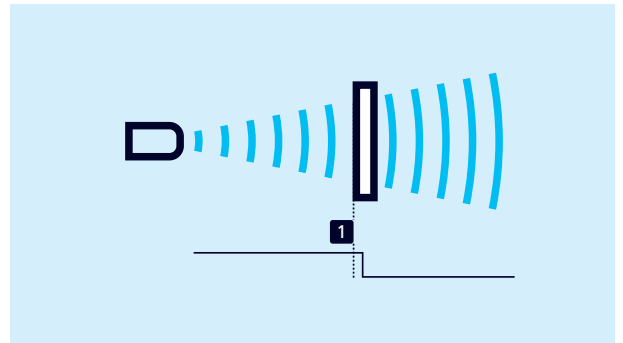

Fig. 7: Switching point (Method B), single point + set point offset

Operating mode: Window mode

- › Switching mode: Window
- › Parameter: Index 61 Subindex 2 = 2, see chap. 4.3

The switching output is set if the object is within a window defined by two window limits. This can be used, for example, to monitor the correct bottle size in a drinks crate. Bottles that are too high and too low are sorted out (see Fig. 8).

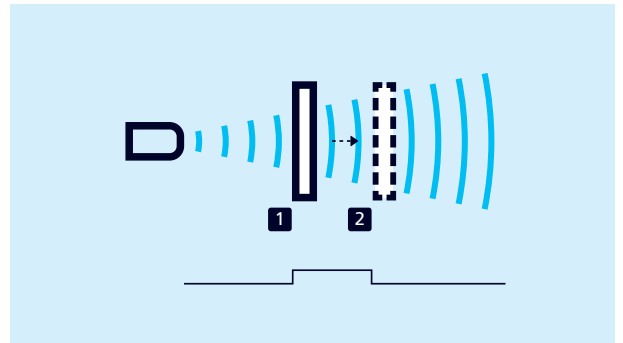

Fig. 8: Window mode, window

Operating mode: Two way reflective barrier

- › Switching mode: Window ± set point offset
- › Parameter: Index 61 subindex 2 = 129, see chap. 4.3

The output is set when the object is located between the sensor and a fixed reflector.

To this end, the ultrasonic sensor is set in window mode so that a fixed reflector lies inside the window. The switching output is changed as soon as an object is detected in front of the reflector. This operating mode is recommended for materials that are difficult to detect, such as foam, and for scanning objects with irregular surfaces (see Fig. 9).

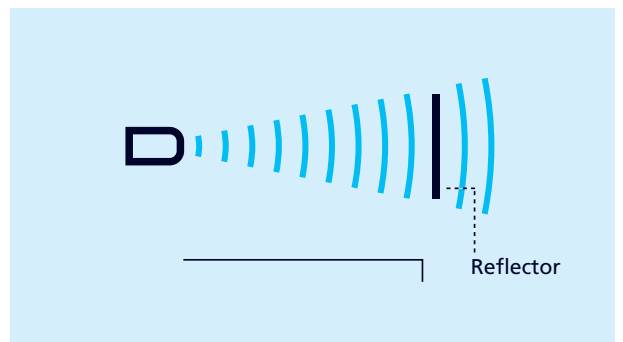

Fig. 9: Two way reflective barrier, window ± set point offset

Operating mode: Hysteresis mode

- › Switching mode: Two-point
- › Parameter: Index 61 Subindex 2 = 3, see chap. 4.3

The state of the switching output changes when the object reaches switching point 1 and changes back to the previous state value when the object reaches switching point 2 (see Fig. 10). Two-point control can be realised using this operating mode. A typical application is filling level control, e.g. in a tank with a maximum level (switch point 1) and a minimum level (switching point 2).

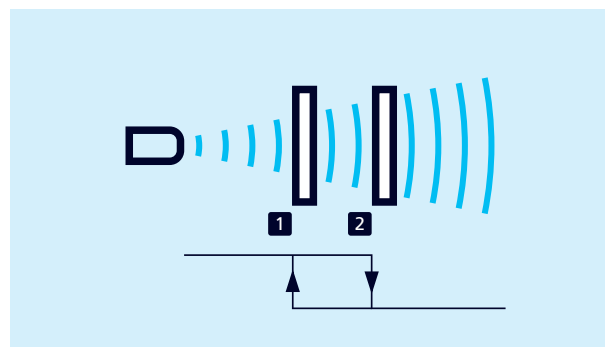

Fig. 10: Hysteresis mode, two point

6 Setting the sensor with Teach-in

Various Teach-in methods are available to set the switching points for the selected operating mode or switching mode. Teach-in is possible on-site on the sensor and via IO-Link.

6.1 Teach-in via pin 2 on the sensor

The sensor can be set via pin 2 (Com) with Teach-in. The following operating modes are available for on-site operation:

- › Setting the switching point - Method A/Method B
- › Window mode
- › Two way reflective barrier
- ➔ Follow the instructions in the sensor operating manual for the Teach-in procedures.

Note

The input options for pin 2 can be defined via the IO-Link parameter index 370. Pin 2 can be deactivated to lock the sensor against inputs.

Table 4: IO-Link parameters – Pin 2 mode

Index	Subindex	Designation	Format	Access	Factory setting	Value range
370	1	Mode	UInt8	RW	1	0 = Inactive 1 = Active

6.2 Teach-in parameters via IO-Link

The following section lists the parameters relevant for Teach-in operations via IO-Link. Details about the parameters can be found in the parameter overview in chapter 8.

Table 5: IO-Link parameters – Teach-in

Index	Designation	Description
2	Standard Command	Execution of the single point Teach-in for SP1 or SP2: 65 = SP1 single value Teach-in 66 = SP2 single value Teach-in
58	Teach-in channel	Selection of the target channel for the Teach-in procedure: 0 = SSC1: Pin 4 (Push-Pull) (default) 1 = SSC1: Pin 4 (Push-Pull)
59	Bit 0-3: Teach-in status	The Teach-in result indicates the state of the current adjustment: 0 = Idle 1 = SP1 success 2 = SP2 success 7 = Error

6.2.1 Teach-in via IO-Link



Setting the single point (switching point - Method A)

1. Position the object at the desired distance in front of the sensor.
 2. Write the value 1 in parameter index 61 subindex 2 (SSC1 configuration, mode).
 3. Write the value 65 in parameter index 2 (Standard command).
 4. Optional: Read out parameter »Teach-in status« (index 59).
- ◆ When the Teach-in of the switching output SSC1 is successful, the value = 1

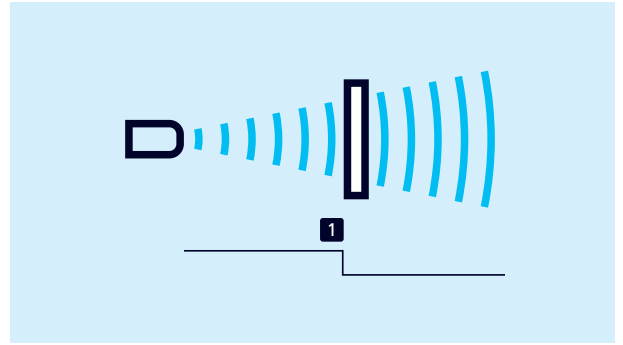

Setting single point + offset (switching point - Method B)

1. Position the object at the desired distance in front of the sensor.
 2. Write the value 128 in parameter index 61 subindex 2 (SSC1 configuration, mode).
 3. Write the value 65 in parameter index 2 (Standard command).
 4. Optional: Read out parameter »Teach-in status« (index 59).
- ◆ When the Teach-in of the switching output SSC1 is successful, the value = 1.

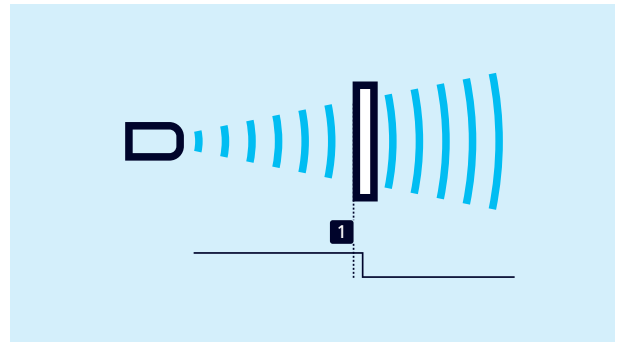

Setting the window (window mode)

1. Position object at position 1.
 2. Write the value 2 in parameter index 61 subindex 2 (SSC1 configuration, mode).
 3. Write the value 65 in parameter index 2 (Standard command).
 4. Position object at position 2.
 5. Write the value 66 in parameter index 2 (Standard command).
 6. Optional: Read out parameter »Teach-in status« (index 59).
- ◆ When the Teach-in of the switching output SSC1 is successful, the value = 2.

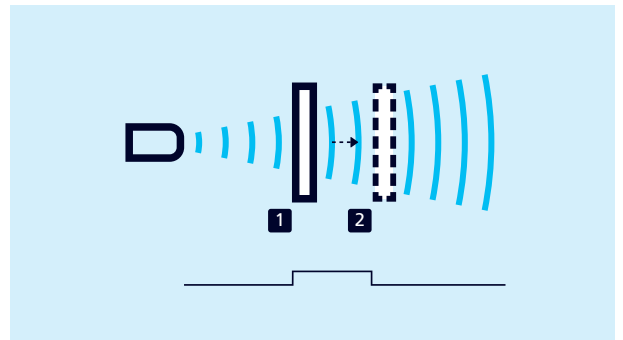

Setting window ± offset (two-way reflective barrier)

1. Position the reflector at the desired distance in front of the sensor.
 2. Write the value 129 in parameter index 61 subindex 2 (SSC1 configuration, mode).
 3. Write the value 65 in parameter index 2 (Standard command).
 4. Optional: Read out parameter »Teach-in status« (index 59).
- ◆ When the Teach-in of the switching output SSC1 is successful, the value = 1.

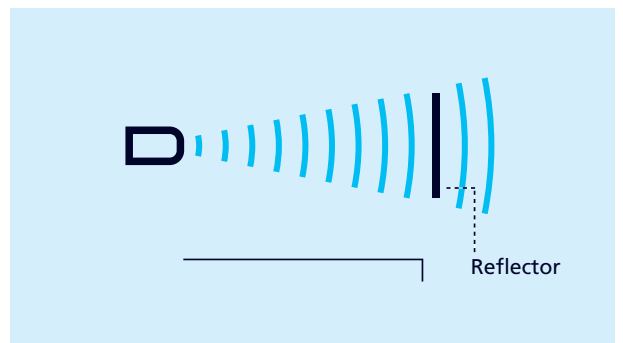



Setting hysteresis mode

1. Position object at position 1.
 2. Write the value 3 in parameter index 61 subindex 2 (SSC1 configuration, mode).
 3. Write the value 65 in parameter index 2 (Standard command).
 4. Position object at position 2.
 5. Write the value 66 in parameter index 2 (Standard command).
 6. Optional: Read out parameter »Teach-in status« (index 59).
- ◆ When the Teach-in of the switching output SSC1 is successful, the value = 2

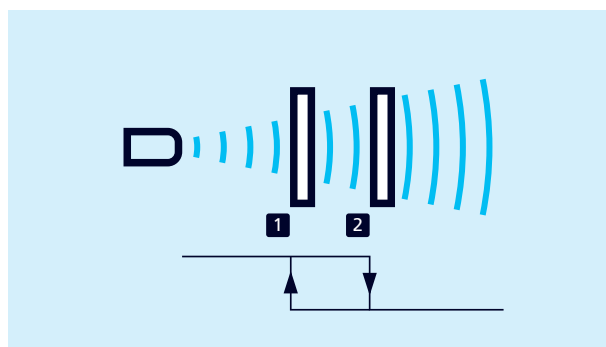

7 Further settings via IO-Link

7.1 Synchronisation and Multiplex mode

Synchronisation

Synchronisation avoids mutual interference between the sensors and should be used if the installation system prevents maintenance of the specified minimum installation distances (see associated operating manual).

There are two types of synchronisation to choose from:

- › Integrated synchronisation for SIO mode
- › Synchronisation via IO-Link

All sensors measure at exactly the same time in synchronisation mode.

Table 6: IO-Link parameters - Synchronisation and multiplex operation

Index	Sub-index	Designation	Format	Access	Factory setting	Value range
350	0	Synchronisation and multiplex operation	Record			
	1	Mode	UInt8	RW	1	0 = Inactive 1 = Active
	2	Sensor operation	UInt8	RW	0	0 = Synchronisation active 1 = Multiplex address 1 ... 10 = Multiplex address 10 128 = IO-Link synchronisation active
	3	Multiplex number of participants	UInt8	RW	10	2 = 2 participants ... 10 = 10 participants



Activating integrated synchronisation for SIO-Mode

Up to 10 sensors can be synchronised.

1. Connect all sensors that are to be synchronised electrically via pin 5.
 2. Set parameter index 350 subindex 1 (mode) to the value 1.
 3. Set parameter index 350 subindex 2 (sensor mode) to the value 0.
- ◆ The integrated synchronisation is active.

Note

Integrated synchronisation is not supported via IO-Link.

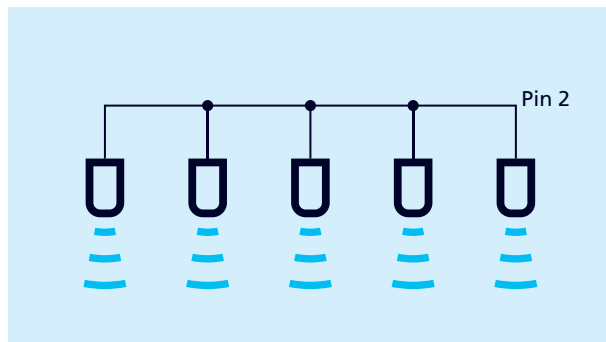



Setting synchronisation via IO-Link (index 350)

Observe the following points when synchronising via IO-Link:

- › The number of sensors that can be synchronised via IO-Link depends on the technical properties of the IO-Link master used and is limited to 10 sensors.
- › The IO-Link master used must support the »Message sync« function.
- › The cycle time to be set on the IO-Link master is calculated according to the following formula:

$$\text{Cycle time [ms]} = \text{largest repetition rate [ms]} + \text{number of sensors} \times 3.4$$

1. Connect all sensors that are to be synchronised electrically via pin 2.
 2. Set parameter index 350 subindex 1 (mode) to the value 1.
 3. Set parameter index 350 subindex 2 (sensor mode) to the value 128.
- ◆ The IO-Link synchronisation is active.

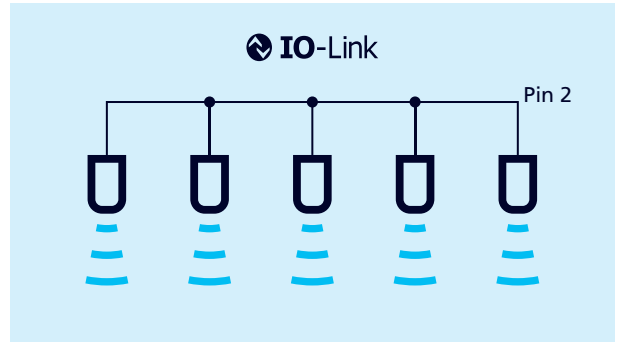

Setting Multiplex mode for SIO mode

In this sensor mode, each sensor can only receive echo signals from its own transmission pulse, which completely prevents reciprocal interference between the sensors. Each sensor is assigned a multiplex address from 1 to 10. The sensors then measure the addresses one after each other in ascending sequence.

Note

Multiplex mode is not supported via IO-Link.

1. Connect all sensors that are to work in Multiplex mode electrically via pin 2.
 2. Assign a multiplex address to the sensors via parameter index 350 subindex 2 (sensor mode).
 3. Set the number of participants via parameter 350 subindex 3 (number of Multiplex participants).
- ◆ The sensors operate in Multiplex mode.

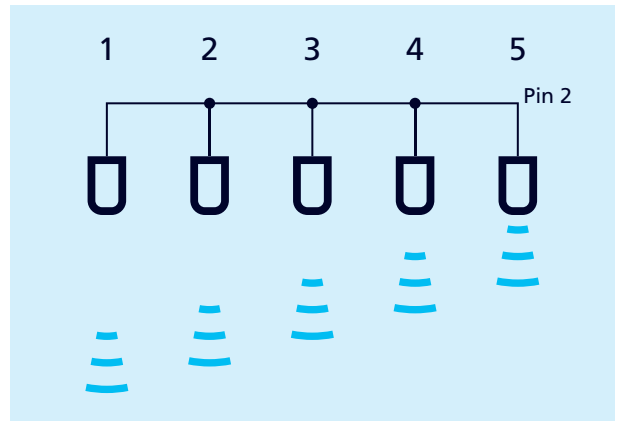

7.2 Sound field width & Sensitivity

One of the three pre-defined detection area configurations (Narrow & Low, Normal & Standard, Wide & High) can be selected via the »Sound field width & Sensitivity« parameter, see Fig. 11. The factory setting »Wide & High« can be used for most applications.

The setting »Narrow & Low« may be necessary, for example, if objects on the periphery of the sound field exercise an undesirable influence on the measured values.

With the »Sensitivity hysteresis« parameter, the sensitivity is increased at the moment at which an object is detected and the switching output switches. We recommend activating the sensitivity hysteresis, if for example, the operating mode switching output (Method B) is used and objects enter the sound field laterally.

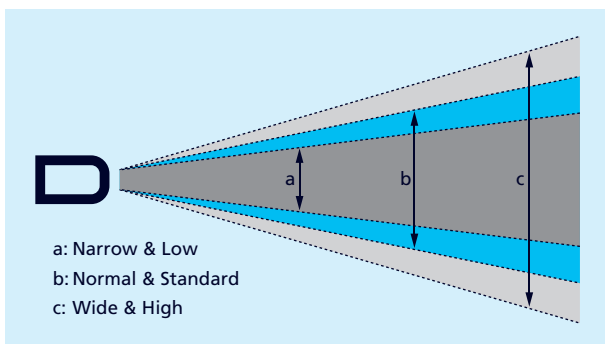

Fig. 11: Setting options for the sound field width

Note

A reduced detection zone width is always accompanied by reduced sensitivity.

Table 7: IO-Link parameters – Sound field width & Sensitivity

Index	Sub-index	Designation	Format	Access	Factory setting	Value range
220	0	Sound field width & Sensitivity	Record			
	1	Amplifier setting	UInt8	RW	2	0 = Narrow & Low 1 = Normal & Standard 2 = Wide & High
	2	Sensibility hysteresis	UInt8	RW	0	0 = Inactive 1 = Active

7.3 Measurement configuration

Foreground suppression can be set via the measurement configuration. Here, the echo signal is suppressed in a range – from the blind zone to the set value (see Fig. 12).

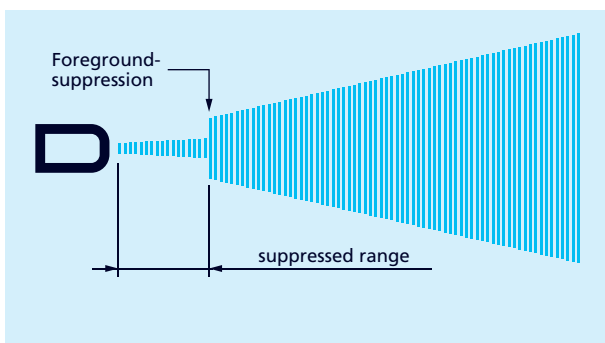

Fig. 12: Measurement configuration – foreground suppression

Table 8: IO-Link parameters – Measurement configuration

Index	Sub-index	Designation	Format	Access	Factory setting	Value range	Resolution
200	0	Measurement configuration	Record				
	1	Foreground suppression	Int16	RW	nano-15 = 200 nano-24 = 400	200...600 400...1,200	0.1 mm 0.1 mm

7.4 Filter

The results of the cyclically performed measurements of the ultrasonic sensor are not sent directly to the output, but pass through internal software filters that have the task of filtering out measured value outliers and smoothing and damping the measurement course.

The following filter types are available:

- › F00: no filter
- › F01: standard filter
- › F02: averaging filter
- › F03: foreground filter
- › F04: background filter

In addition, the filter strength can be set from P00 (weak filter effect) to P09 (strong filter effect). Most applications can be solved with the standard filter F01. For sensors with an analogue output, the mean value filter F02 is activated as standard in order to obtain a smoothed output signal.

Changes to the filter settings require experience and are usually not necessary for standard applications. Should you have any questions about filter settings, we recommend that you contact **microsonic.**

Table 9: IO-Link parameters – Filter settings

Index	Sub-index	Designation	Format	Access	Factory setting	Value range
256	0	Filter	Record			
	1	Type	UInt8	RW	1	0 = F00: no filter 1 = F01: standard filter 2 = F02: averaging filter 3 = F03: foreground filter 4 = F04: background filter
	2	Strength	UInt8	RW	0	0 = P00: weak filter 1 = P01 ... 8 = P08 9 = P09: strong filter
	3	Maximum object speed	Int8	RW	25	10...25, resolution 0.1m/s

7.5 Temperature compensation

The sensor has an internal temperature compensation, which compensates for the temperature dependence of the sound velocity in the air. The internally measured tempera-

ture (assumed air temperature) is evaluated on the factory side. Alternatively, a fixed reference temperature in the range -25 to +70 °C can be entered.

Table 10: IO-Link parameters – Temperature compensation

Index	Sub-index	Designation	Format	Access	Factory setting	Value range
300	0	Temperature compensation	Record			
	1	Source	UInt8	RW	1	0 = fixed Value 1 = Internal Temperatureprobe
	2	fixed Value	Int8	RW	20	-25...70, resolution in 1 °C

7.5.1 Temperature compensation diagnosis

The sensor displays the current temperature prepared for temperature compensation. This is only used if index 300 subindex 1 is set to the value 1.

Table 11: IO-Link parameters – Temperature compensation diagnosis

Index	Sub-index	Designation	Format	Access	Factory setting	Value range
2000	0	Temperature compensation diagnosis	Record			
	1	Sensor temperature	Int16	RO	200	-560...1.560, resolution in 0.1 °C
	2	Heating-up phase	UInt8	RO		0 = Not completed 1 = Completed

7.6 LED

The LEDs of the sensor can be deactivated via the parameter index 371 (LED).

Table 12: IO-Link parameters – LED mode

Index	Sub-index	Designation	Format	Access	Factory setting	Value range
371	0	LED	Record			
	1	Mode	UInt8	RW	1	0 = Inactive 1 = Active

7.7 Returning to factory setting

If the value 130 is written in index 2, all parameters of the sensor are reset to the factory setting.

Table 13: IO-Link parameters – Standard Command - Restore Factory Settings

Index	Designation	Format	Access	Factory setting	Value range
2	Standard Command	UInt8	WO		130 = Restore Factory Settings

7.8 Device Access Locks

The device access locks are specified IO-Link functions. The »Device access locks« parameter enables the control of the device behaviour. Device functions can be deactivated superordinately and globally via defined bits in this parameter.

Parameter (write) Access Lock

If this bit is set, write access to application parameters and some IO-Link-specific parameters is blocked.

Local Parameterization Lock

If this bit is set, parametrisation via local operating elements such as button/pin 5 on the device is blocked.

Table 14: IO-Link parameters – Device access locks

Index	Designation	Format	Access	Factory setting	Value range
12	Device access locks	Record	RW	0	
	Bit 0: Parameter (write) Access Lock	Boolean	RW	0	0 = Unlocked 1 = Locked
	Bit 2: Local Parameterisation Lock	Boolean	RW	0	0 = Unlocked 1 = Locked

7.9 Identification

Vendor Name

The manufacturer's name contains the name of the manufacturer.

Vendor Text

The manufacturer's text contains the manufacturer's claim.

Product Name

The product name contains the designation of the sensor used.

Product ID

The product ID contains the article number of the sensor used.

Product Text

The product text describes the sensor used.

Serial Number

The serial number is determined by the manufacturer.

Hardware Version

The hardware revision shows the hardware revision of the application used by the manufacturer.

Firmware Version

The firmware version shows the firmware version of the application used by the manufacturer.

Application Specific Tag

The application-specific code can be used to store explanatory information about the sensor's application.

Table 15: IO-Link parameters – Identification

Index	Designation	Format	Access	Factory setting
16	Vendor Name	String	RO	microsonic GmbH
17	Vendor Text	String	RO	Unser Herz schallt ultra.
18	Product Name	String	RO	nano-15/CF nano-24/CF
19	Product ID	String	RO	nano-15 = 34020 nano-24 = 34021
20	Product Text	String	RO	Ultrasonic sensor
21	Serial Number	String	RO	
22	Hardware Version	String	RO	
23	Firmware Version	String	RO	
24	Application Specific Tag	String	RW	***

7.10 Device status

Error count

The error count is incremented as soon as an error is detected in the sensor. The counter is set to 0 every time the operating voltage is switched on.

Device status

If no events can be read out or the sensor is switched from SIO mode into IO-Link mode and the sensor is still to be monitored, we recommend querying this variable cyclically. The device status shows the entire status of the sensor depending on the problem that has occurred.

Detailed device status

The detailed device status lists all active error messages and warnings until they are revoked by the sensor as soon as the reason has been rectified.

Table 16: IO-Link parameters – Device status

Index	Format	Designation	Access	Factory setting	Value range
32	UInt16	Error count	RO	0	0...65,535
36	UInt8	Device status	RO	0	0 = Device is OK 1 = Maintenance required 2 = Out of specification 3 = Functional check 4 = Failure
37	Array	Detailed device status	RO	0	

7.11 Events

Events are sent from the sensor to the master. This is performed asynchronously via the ISDU channel. The master acknowledges these events in the sensor and stores them in the master memory. There, a PLC control can read out the events. Several events can be pending in the sensor at the same time.

Events are divided into three types:

- › **Notifications** are displays of general information or non-critical states of the sensor. They are issued upon every re-occurrence of the sensor state.

- › **Warnings** indicate a possible functional restriction of the sensor. These events remain until the reason for the functional restriction has been rectified.
- › **Error** events indicate an inoperative sensor. These displays remain pending until the reason for the functional restriction has been rectified.

Table 17: IO-Link-Events

Code		Type	Name	Meaning/measure
dezimal	hex			
16384	0x4000	Error	Temperature fault	Overload
16912	0x4210	Warning	Device temperature over-run	The maximum permissible sensor temperature was exceeded.
16928	0x4220	Warning	Device temperature under-run	The minimum permissible sensor temperature was undercut.
20736	0x5100	Error	General power supply fault	Check the supply voltage.
30480	0x7710	Error	Short circuit	Check the installation
36000	0x8ca0	Notification	Teach-in error	A Teach-in procedure was not successful.
36001	0x8ca1	Notification	Teach-in success	A Teach-in procedure was successful.
36002	0x8ca2	Notification	CycleTime error	A CycleTime error is triggered if the CycleTime does not correspond to the permitted configuration.

7.12 Data storage

The sensors support data storage in accordance with IO-Link specification 1.1.2. Data storage allows the master to store the entire parameter set of the sensor. If the sensor is replaced, the master writes the data back into the replacement device. Data storage is completely controlled by the master and is a function of the IO-Link to be configured in the master. No further settings need to be made in the sensor for data storage.

Note

The configuration of the IO-Link master is decisive for the handling of the parameter set when storing data.

- ➔ **Comply with the specifications of the documentation and configuration of the IO-Link master!**

7.13 Block parametrisation

Block parametrisation is a specified IO-Link function. We recommend using this function if several parameters are to be changed simultaneously. Each individual parameter write access is implemented directly in the sensor. This also includes a consistency test against other parameters and immediate transfer to the application if the check is successful. If parameters are transferred in an unfavourable sequence, the consistency test may fail.

With block parametrisation on the other hand, all parameters are first written and then the consistency test is carried out for all transferred parameters. The parameters are only saved in the sensor if this consistency test was successful. This block parametrisation applies analogously to the reading out of parameters.

Table 18: IO-Link Standard command – Block parametrisation

Index	Designation	Format	Access	Factory setting	Value range
2	Standard Command	UInt8	WO		1 = ParamUploadStart 2 = ParamUploadEnd 3 = ParamDownloadStart 4 = ParamDownloadEnd 5 = ParamDownloadStore 6 = ParamBreak

7.14 Parameter access and error codes

The master issues cyclical requests for the sensor to communicate. The measured value is sent from the sensor to the master with each communication. Part of this communication is the Indexed Service Data Unit channel (ISDU channel). This is used to write data into or read data out of the sensor acyclically.

This means that writing or reading a parameter can take several communication cycles.

Each communication of the master via the ISDU channel is answered by the sensor. The sensor first processes a transferred parameter when it has been transferred completely. Parameters, diagnostic data, events and commands are sent via this ISDU channel.

If the sensor detects errors during parameter access, it reports these with corresponding error codes.

Table 19: IO-Link error codes

Error code		Meaning/measure
dezimal	hex	
0	0x0000	No error
32768	0x8000	Application error in the device - no details
32785	0x8011	Index not available
32786	0x8012	Subindex not available
32800	0x8020	Service currently not available
32801	0x8021	The parameter cannot be accessed at the moment, as the device is currently in a local operating mode.
32802	0x8022	The parameter cannot be accessed at the moment because the device is currently in a remote operating mode.
32803	0x8023	Access denied
32816	0x8030	Parameter value outside the valid range
32817	0x8031	Parameter value above the permissible limit
32818	0x8032	Parameter value below the permissible limit
32819	0x8033	Parameter length too small
32820	0x8034	Written parameter length is smaller than allowed
32821	0x8035	Function not available
32822	0x8036	Function currently not available
32832	0x8040	Invalid parameter set
32833	0x8041	Inconsistent parameter set
32898	0x8082	Application not ready
33024	0x8100	Parameter SP1 cannot be taught/set via foreground suppression
33025	0x8101	Parameter SP2 cannot be taught/set via foreground suppression
33026	0x8102	Parameter SP1 cannot be taught/set via the upper limit value
33027	0x8103	Parameter SP2 cannot be taught/set via the upper limit value
33028	0x8104	Parameter SP1 cannot be taught/set via upper limit value - hysteresis
33029	0x8105	Parameter SP2 cannot be taught/set via upper limit value - hysteresis
33030	0x8106	Parameter SP1 cannot be taught/set via foreground suppression + hysteresis
33031	0x8107	Parameter SP2 cannot be taught/set via foreground suppression + hysteresis
33032	0x8108	The distance between parameters SP1 and SP2 must be at least 2x hysteresis
33033	0x8109	Parameter SP1 cannot be taught/set via upper limit value - hysteresis offset.
33034	0x810A	Parameter SP1 cannot be taught/set via foreground suppression + hysteresis + offset
33035	0x810B	The distance between parameters SP1 and SP2 must be at least 1 mm

8 Appendix: Overview IO-Link data

Index	Sub-index	Designation	Format	Access	Factory setting	Value range
2		Standard Command	UInt8	WO		1 = ParamUploadStart 2 = ParamUploadEnd 3 = ParamDownloadStart 4 = ParamDownloadEnd 5 = ParamDownloadStore 6 = ParamBreak 65 = SP1 single value teach-in 66 = SP2 single value teach-in 130 = Restore Factory Settings
12		Device Access Locks	Record	RW		
		Bit 0: Parameter (write) Access Lock		RW	0	0 = Unlocked 1 = Locked
		Bit 2: Local Parameterisation Lock		RW	0	0 = Unlocked 1 = Locked
16		Vendor Name	String	RO	microsonic GmbH	
17		Vendor Text	String	RO	Unser Herz schallt ultra.	
18		Product Name	String	RO	nano-15/CF nano-24/CF	
19		Product ID	String	RO	nano-15 = 34020 nano-24 = 34021	
20		Product Text	String	RO	Ultrasonic sensor	
21		Serial Number	String	RO		
22		Hardware Version	String	RO		
23		Firmware Version	String	RO		
24		Application Specific Tag	String	RW	***	
32		Error Count	UInt16	RO	0	0..65.535
36		Device Status	UInt8	RO	0	0 = Device is OK 1 = Maintenance required 2 = Out of specification 3 = Functional check 4 = Failure 5...255 = Reserved
37		Detailed Device Status	Array	RO		
40		Process data	Record	RO		
		Bit 0: Switch signal channel 1 state	Boolean			
		Bit 8-15: Process data scale	Int8			
		Bit 16-31: Process data value	Int16			
58		Teach-in channel	UInt8	RW	0	0 = SSC1: Pin 4 (Push-Pull) (default) 1 = SSC1: Pin 4 (Push-Pull)
59		Teach-in Result	Record			
		Bit 0-3: Teach-in status	UInt4	RO	0	0 = Idle 1 = SP1 success 2 = SP2 success 7 = Error
60	0	SSC1 parameter	Record			
	1	SP1	Int16	RW	nano-15 = 1,500 nano-24 = 2,500	200...2,500, resolution 0.1 mm 400...3,500, resolution 0.1 mm
	2	SP2	Int16	RW	nano-15 = 1,700 nano-24 = 2,800	200...2,500, resolution 0.1 mm 400...3,500, resolution 0.1 mm

Index	Sub-index	Designation	Format	Access	Factory setting	Value range
61	0	SSC1 configuration	Record			
	1	Logic	UInt8	RW	0	0 = High active 1 = Low active
	2	Mode	UInt8	RW	1	0 = Deactivated 1 = Single point (SP1: switching point) 2 = Window (SP1, SP2: window mode) 3 = Two point (SP1, SP2: hysteresis mode) 128 = Single point + set point offset (SP1: switching point + offset) 129 = Window ± set point offset (SP1: two way reflective barrier)
	3	Hysteresis	UInt16	RW	nano-15 = 20 nano-24 = 30	10...2,300 10...3,100
100	0	SSC1 advanced configuration	Record			
	1	Switch-on delay	UInt8	RW	0	0...255, resolution 0.1 second
	2	Switch-off delay	UInt8	RW	0	0...255, resolution 0.1 second
	3	Set point offset	UInt8	RW	8	2...20, resolution 1 %
200	0	Measurement configuration	Record			
	1	Foreground suppression	Int16	RW	nano-15 = 200 nano-24 = 400	200...600, resolution 0.1 mm 400...1,200, resolution 0.1 mm
220	0	Sound field width & Sensitivity	Record			
	1	Amplifier setting	UInt8	RW	2	0 = Narrow & Low 1 = Normal & Standard 2 = Wide & High
	2	Sensibility hysteresis	UInt8	RW	0	0 = Inactive 1 = Active
256	0	Filter	Record			
	1	Type	UInt8	RW	1	0 = F00: no filter 1 = F01: standard filter 2 = F02: averaging filter 3 = F03: foreground filter 4 = F04: background filter
	2	Strength	UInt8	RW	0	0 = P00: weak filter 1 = P01 2 = P02 3 = P03 4 = P04 5 = P05 6 = P06 7 = P07 8 = P08 9 = P09: strong filter
	3	Maximum object speed	Int8	RW	25	10...25, resolution 0.1m/s
300	0	Temperature compensation	Record			
	1	Source	UInt8	RW	1	0 = fixed Value 1 = Internal Temperatureprobe
	2	fixed Value	Int8	RW	20	-25...70, resolution in 1 °C

Index	Sub-index	Designation	Format	Access	Factory setting	Value range
350	0	Synchronisation and multiplex operation	Record			
	1	Mode	UInt8	RW	1	0 = Inactive 1 = Active
	2	Sensor operation	UInt8	RW	0	0 = Synchronisation active 1 = Multiplex address 1 2 = Multiplex address 2 3 = Multiplex address 3 4 = Multiplex address 4 5 = Multiplex address 5 6 = Multiplex address 6 7 = Multiplex address 7 8 = Multiplex address 8 9 = Multiplex address 9 10 = Multiplex address 10 128 = IO-Link synchronisation active
	3	Multiplex number of participants	UInt8	RW	10	2 = 2 participants 3 = 3 participants 4 = 4 participants 5 = 5 participants 6 = 6 participants 7 = 7 participants 8 = 8 participants 9 = 9 participants 10 = 10 participants
370	0	Pin 2	Record			
	1	Mode	UInt8	RW	1	0 = Inactive 1 = Active
371	0	LED	Record			
	1	Mode	UInt8	RW	1	0 = Inactive 1 = Active
2000	0	Temperature compensation diagnosis	Record			
	1	Sensor temperature	Int16	RO	200	-560...1.560, resolution in 0.1 °C
	2	Heating-up phase	UInt8	RO		0 = Not completed 1 = Completed
16512	0	Measurement data channel description	Record			
	1	Lower limit	Int32	RO	nano-15 = 200 nano-24 = 400	200...600, resolution 0.1 mm 400...1,200, resolution 0.1 mm
	2	Upper limit	Int32	RO	nano-15 = 2,500 nano-24 = 3,500	2,500 resolution 0.1 mm 3,500 resolution 0.1 mm
	3	Unit code	UInt16	RO	nano-15 = 1013 nano-24 = 1013	
	4	Scale	Int8	RO	nano-15 = -1 nano-24 = -1	