

Operating manual
Ultrasonic proximity switch with one switching output and IO-Link
 cube-35/F
 cube-130/F
 cube-340/F

Product Description
 The cube sensor offers a non-contact measurement of the distance to an object which must be positioned within the sensor's detection zone. The switching output is set conditional upon the adjusted switching distance.

Safety Notes

- Read the operating manual prior to start-up.
- Connection, installation and adjustments may only be carried out by qualified staff.
- No safety component in accordance with the EU Machine Directive, use in the area of personal and machine protection not permitted.

Proper Use
 cube ultrasonic sensors are used for non-contact detection of objects.

IO-Link
 The cube sensor is IO-Link-capable in accordance with IO-Link specification V1.1 and supports Smart Sensor Profile like Measuring and Switching Sensor. The sensor can be monitored and parameterised via IO-Link.

Installation

- ➔ Mount the sensor at the place of fitting, see »QuickLock mounting bracket«.
- ➔ Connect a connection cable to the M12 device plug, see Fig. 2.
- ➔ If necessary, use the alignment assistance (see »Using the Alignment Assistance«).

Start-up

- ➔ Connect the power supply.
- ➔ Set the parameters of the sensor, see Diagram 1.

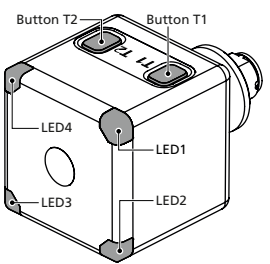

Fig. 1: Controls of the cube sensor

Controls of the cube sensor
 The sensor can be operated using the push buttons T1 and T2. Four LEDs indicate the operation and the state of the output, see Fig. 1 and Fig. 3.

Pin	microsonic notation	IO-Link notation	IO-Link Smart Sensor Profile	colour
1	+U _B	L+		brown
2	-	-		white
3	-U _B	L-		blue
4	F	Q	SSC	black
5	Com	NC		grey

Fig. 2: Pin assignment with view onto sensor plug, IO-Link notation and colour coding of the microsonic connection cables

LED	Colour	Indicator	LED...	Meaning
LED1	yellow	state of output	on	output is set
			off	output is not set
LED2	green	power indicator	on	normal operating mode
			flashing	IO-Link mode
LED3	green	power indicator	on	normal operating mode
			flashing	IO-Link mode
LED4	yellow	state of output	on	output is set
			off	output is not set

Fig. 3: Description of the LED indicators

Diagram 1: Set sensor via Teach-in procedure

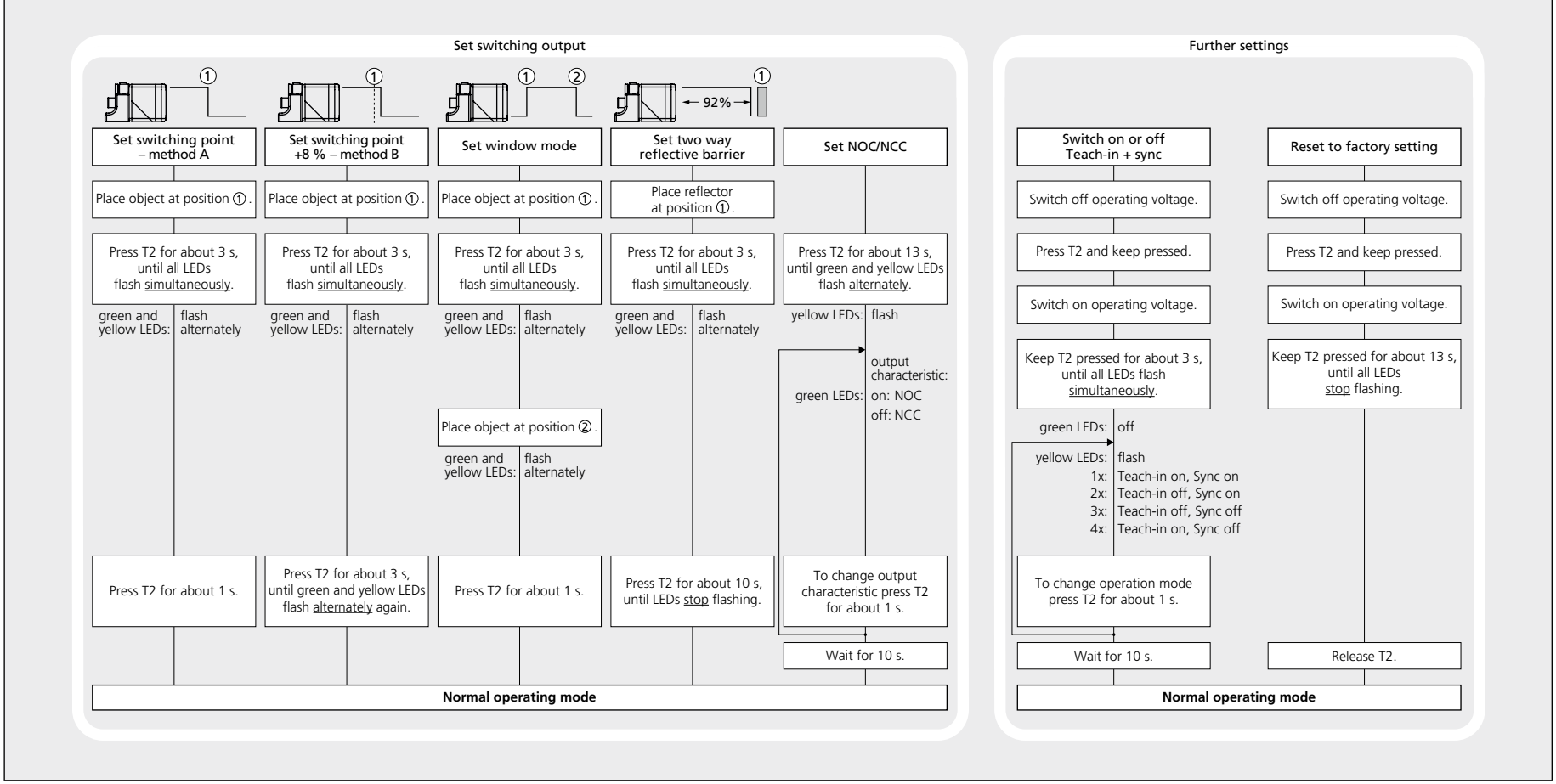

Operating Modes

- **Operation with one switching point**
 The switching output is set when the object falls below the set switching point.
- **Window mode**
 The switching output is set when the object is within the window limits.
- **Two-way reflective barrier**
 The switching output is set when the object is between sensor and fixed reflector.

Synchronisation

If the assembly distance of multiple sensors falls below the values shown in Fig. 4, they can influence one another. To avoid this, the internal synchronisation should be used (»sync« must be switched on, see Diagram 1). Interconnect each pin 5 of the sensors to be synchronised.

	Minimal distance	Minimal distance with sync
cube-35...	≥0.40 m	≥2.50 m
cube-130...	≥1.10 m	≥8.00 m
cube-340...	≥2.00 m	≥18.00 m

Fig. 4: Minimal assembly distances without synchronisation

QuickLock mounting bracket

The cube sensor is attached using the QuickLock mounting bracket:

- ➔ Insert the sensor into the bracket according to Fig. 5 and press until the bracket audibly engages.

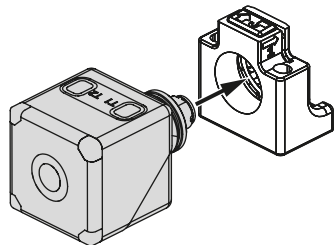

Fig. 5: QuickLock mounting bracket: insert Sensor

The sensor can be rotated around its own axis when inserted into the bracket. Furthermore, the sensor head can be rotated so that measurements can be taken in four different directions, see »Rotatable sensor head«.

The bracket can be locked:

- ➔ Slide the latch (Fig. 6) in the direction of the sensor.

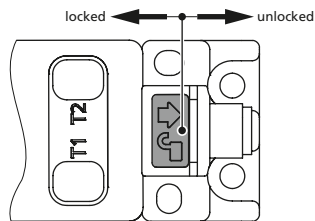

Fig. 6: QuickLock mounting bracket: lock/unlock Sensor

Remove the sensor from the QuickLock mounting bracket:

- ➔ Unlock the latch according to Fig. 6 and press down (Fig. 7). The sensor detaches and can be removed.

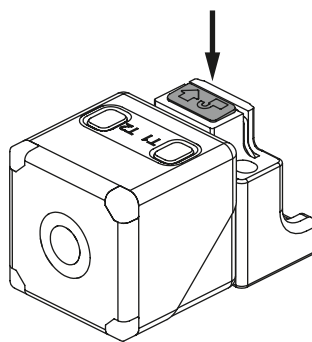

Fig. 7: Remove the sensor

Rotatable sensor head

The cube sensor has a rotatable sensor head, with which the orientation of the sensor can be rotated by 180° (Fig. 8).

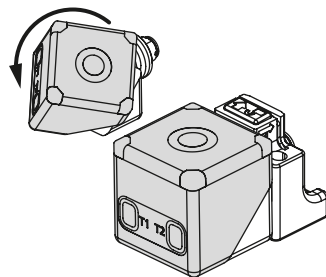

Fig. 8: Rotatable sensor head

Factory Setting

The cube sensor is delivered factory made with the following settings:

- Switching output on operating mode switching point
- Switching output on NOC
- Switching distance at operating range
- Input Com set to »sync«
- Filter at F01
- Filter strength at P00

Using the Alignment Assistance

With the internal alignment assistance the sensor can be optimally aligned to the object during installation. To do this, proceed as follows (see Fig. 9):

- ➔ Mount the sensor loosely at the place of mounting so that it can still be moved.
- ➔ Press T2 shortly. The yellow LEDs flash. The faster the the yellow LEDs flash, the stronger the received signal.
- ➔ Point the sensor at different angles to the object for about 10 seconds so that the sensor can determine the maximum signal level. Afterwards align the sensor until the yellow LEDs light constantly.
- ➔ Screw the sensor in this position.
- ➔ Press T2 shortly (or wait approx. 120 s) to exit the Alignment Assistance. The green LEDs flash 2x and the sensor returns to normal operating mode.

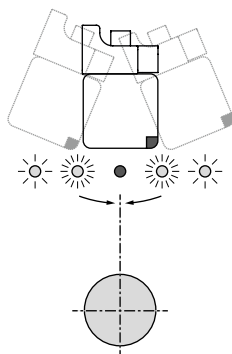

Fig. 9: Align the sensor optimally

Maintenance

microsonic sensors are maintenance-free. In case of excess caked-on dirt we recommend cleaning the white sensor surface.

Notes

- The cube sensor has a blind zone, within which a distance measurement is not possible.
- The cube sensor is equipped with an internal temperature compensation. Due to the sensors self heating, the temperature compensation reaches its optimal working point after approx. 3 minutes of operation.
- The cube sensor has a push-pull switching output.
- Choosing between output function NOC and NCC is possible.
- In the normal operating mode the illuminated yellow LEDs signal that the switching output is set.
- The flashing green LEDs indicate that the sensor is in IO-Link mode.
- If a Teach-in procedure is not completed, all changes are deleted after approx. 30 seconds.
- If all LEDs flash rapidly alternately for approx. 3 seconds during a teach-in procedure, the teach-in procedure was not successful and is discarded.
- In the »Two-way reflective barrier« operating mode, the object has to be within the range of 0 to 92 % of the set distance.
- In the »Set switching point – method A« Teach-in procedure the actual distance to the object is taught to the sensor as the switching point. If the object moves towards the sensor (e.g. with level control) then the taught distance is the level at which the sensor has to switch the output.
- If the object to be scanned moves into the detection area from the side, the »Set switching point +8 % – method B« Teach-in procedure should be used. In this way the switching distance is set 8 % further than the actual measured distance to the object. This ensures a reliable switching behavior even if the height of the objects varies slightly, see Fig. 10.

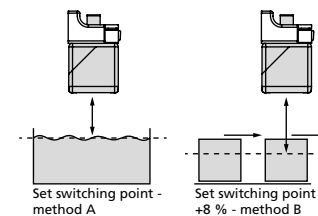

Fig. 10: Setting the switching point for different directions of movement of the object

- The sensor can be reset to its factory setting (see »Further settings«, Diagram 1).
- The cube sensor can be locked against unwanted changes in the sensor via function »Switch on or off Teach-in + sync«, see Diagram 1.
- Using the LinkControl adapter (optional accessory) and the LinkControl software for Windows®, all Teach-in and additional sensor parameter settings can be optionally adjusted.
- The latest IODD file and informations about start-up and configuration of cube sensors via IO-Link, you will find online at: www.microsonic.de/en/cube.

Scope of delivery

- 1x QuickLock mounting bracket

Technical data

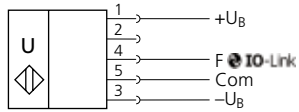

cube-35...

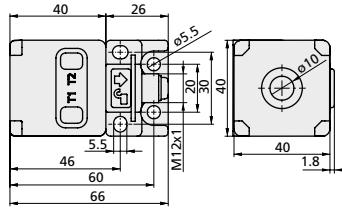

cube-130...

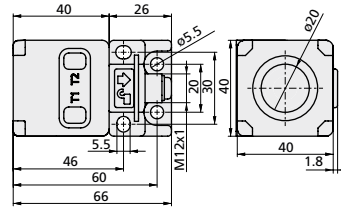

cube-340...

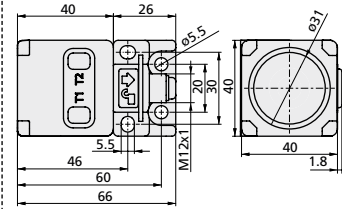

blind zone: 0 to 65 mm
operating range: 350 mm
maximum range: 600 mm
angle of beam spread: see detection zone
transducer frequency: 400 kHz
measurement resolution: 0.056 mm
digital resolution: 0.1 mm

detection zones
 for different objects:
 The dark grey areas represent the zone where it is easy to recognise the normal reflector (round bar). This indicates the typical operating range of the sensors. The light grey areas represent the zone where a very large reflector – for instance a plate – can still be recognised. The requirement here is for an optimum alignment to the sensor. It is not possible to evaluate ultrasonic reflections outside this area.

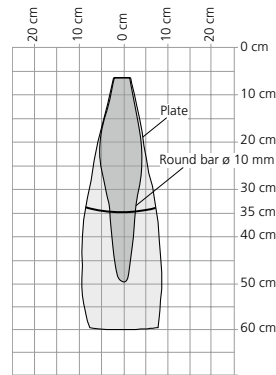

blind zone: 0 to 200 mm
operating range: 1,300 mm
maximum range: 2,000 mm
angle of beam spread: see detection zone
transducer frequency: 200 kHz
measurement resolution: 0.224 mm
digital resolution: 1.0 mm

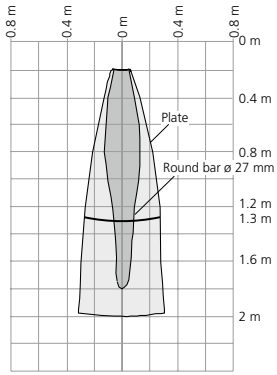

blind zone: 0 to 350 mm
operating range: 3,400 mm
maximum range: 5,000 mm
angle of beam spread: see detection zone
transducer frequency: 120 kHz
measurement resolution: 0.224 mm
digital resolution: 1.0 mm

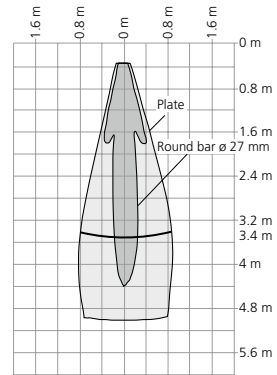

reproducibility: ±0.15 %
accuracy: ±1 % (Temperature drift internal compensated, may be deactivated ¹⁾, 0.17%/K without compensation)

operating voltage U_B: 9 to 30 V DC, reverse polarity protection (Class 2)

voltage ripple: ±10 %

no-load supply current: ≤50 mA

housing: PA, Ultrasonic transducer: polyurethane foam, epoxy resin with glass content

class of protection to EN 60529: IP 67

norm conformity: EN 60947-5-2

type of connection: 5-pin initiator plug, PBT

controls: 2 push-buttons

indicators: 2x LED green, 2x LED yellow

programmable: Teach-in via push button, LinkControl, IO-Link

IO-Link: V1.1

operating temperature: -25 to +70 °C

storage temperature: -40 to +85 °C

weight: 120 g

switching hysteresis ¹⁾: 5 mm

switching frequency ²⁾: 12 Hz

response time ²⁾: 64 ms

time delay before availability: <300 ms

order No.: cube-35/F

switching outputs: push pull, U_B-3 V, -U_B+3 V, I_{max} = 100 mA

switchable NOC/NCC, short-circuit-proof

reproducibility: ±0.15 %
accuracy: ±1 % (Temperature drift internal compensated, may be deactivated ¹⁾, 0.17%/K without compensation)

operating voltage U_B: 9 to 30 V DC, reverse polarity protection (Class 2)

voltage ripple: ±10 %

no-load supply current: ≤50 mA

housing: PA, Ultrasonic transducer: polyurethane foam, epoxy resin with glass content

class of protection to EN 60529: IP 67

norm conformity: EN 60947-5-2

type of connection: 5-pin initiator plug, PBT

controls: 2 push-buttons

indicators: 2x LED green, 2x LED yellow

programmable: Teach-in via push button, LinkControl, IO-Link

IO-Link: V1.1

operating temperature: -25 to +70 °C

storage temperature: -40 to +85 °C

weight: 120 g

switching hysteresis ¹⁾: 20 mm

switching frequency ²⁾: 8 Hz

response time ²⁾: 96 ms

time delay before availability: <300 ms

order No.: cube-130/F

switching outputs: push pull, U_B-3 V, -U_B+3 V, I_{max} = 100 mA

switchable NOC/NCC, short-circuit-proof

reproducibility: ±0.15 %
accuracy: ±1 % (Temperature drift internal compensated, may be deactivated ¹⁾, 0.17%/K without compensation)

operating voltage U_B: 9 to 30 V DC, reverse polarity protection (Class 2)

voltage ripple: ±10 %

no-load supply current: ≤50 mA

housing: PA, Ultrasonic transducer: polyurethane foam, epoxy resin with glass content

class of protection to EN 60529: IP 67

norm conformity: EN 60947-5-2

type of connection: 5-pin initiator plug, PBT

controls: 2 push-buttons

indicators: 2x LED green, 2x LED yellow

programmable: Teach-in via push button, LinkControl, IO-Link

IO-Link: V1.1

operating temperature: -25 to +70 °C

storage temperature: -40 to +85 °C

weight: 130 g

switching hysteresis ¹⁾: 50 mm

switching frequency ²⁾: 4 Hz

response time ²⁾: 166 ms

time delay before availability: <300 ms

order No.: cube-340/F

switching outputs: push pull, U_B-3 V, -U_B+3 V, I_{max} = 100 mA

switchable NOC/NCC, short-circuit-proof

¹⁾ Can be programmed via LinkControl and IO-Link.

²⁾ With LinkControl and IO-Link, the selected filter setting influences the switching frequency and response time.



UL LISTED Enclosure Type 1
 For use only in industrial machinery NFPA 79 applications.
 The proximity switches shall be used with a Listed (CYJV7) cable/connector assembly rated minimum 32 Vdc, minimum 290 mA, in the final installation.

